

Engineered Components COMPANY

PRODUCT CATALOG

All Encapsulated/Molded Fastening Systems are Patents of:
Engineered Components Co.
5,244,326 ; 5,290,131 ; 12,942,601

HARDWARE FOR TRAILERS & TRUCK BODIES



AUTHORIZED DISTRIBUTION

Tinnerman® Brand Fasteners

Palnut®



Avdel Cherry
TEXTRON

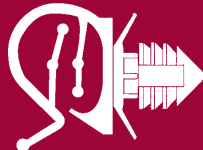

Southco
DRIVE RIVETS



Huck International, Inc.
Advanced Fastening Systems

SPECIALTY PRODUCTS (in stock)



IF IT'S TORX® OR 6 LOBE
● WE HAVE IT



visit our web site for a video tour
www.engcomponents.com

Engineered Components

visit our web site for a video tour
www.engcomponents.com

Our greatest strength over the 30 years of success is our long term team members. Without their loyalty, dedication and skill none of these products would be possible.

Thank you for all they have done.

Terry Smol	29 years	Thomas Whiteley	15 years
Diane Coursey	27 years	Carrie Kagel	11 years
Ray Gorlewski	26 years	Megan Balun	9 years
Kevin Corona	21 years	Ken Berg	9 years
Susan Wright	19 years	Kathy Clendening	9 years
Barb Boope	19 years	Ed Gillard	9 years
AJ Henriksen	18 years	Laura Heck	9 years
Janine Kaminski	18 years	Sid Hirsch	9 years
Jeff Henriksen	17 years	Michelle Pinnelli	9 years
Aimee Poppenga	15 years		

CORPORATE PROFILE

- Anchor Bolt & Screw Company has been in business for over sixty years as a manufacturer and stocking supplier of standard and specialty fasteners.
- The per print division specializes in both metric or inch parts, metal or plastic fasteners or complete components, metal stampings or injection molded parts including plastic, rubber, PVC, and Delrin material. From prototype to production.
- Corporate location in Elgin, IL includes sales and purchasing offices, quality control and test labs and up to 80,000 sq. ft. of warehouse space.
- Corporate warehouse locations also in Lafayette, IN., Mooresville, NC., and a new sales office in Brooksville, FL.
- State of the art graphics department with up to date computer technology for your graphic design from small job to large.
- Partnership with fourteen manufacturers worldwide, four in China, two in Taiwan, one in Malaysia, one in Russia, and six plants besides ourselves in the U.S.A.
- Tier two production part supplier to the automotive industry with a Kan-Ban return container system in place.
- Major stocking supplier for over twenty manufacturers (see reverse)
- Manufacturer of Poly Seal T-Nuts and Bolts in optional colors for the truck body/ truck trailer manufacturing groups.
- For a competitive bid on quality parts, competitive pricing and quick lead times
fax us your RFQ to 847-841-7997

THE PER PRINT SPECIALIST Prototype to Production

(see corporate profile)

STOCKING AUTHORIZED DISTRIBUTOR OF

Avdel/Cherry Fasteners

Gesipa Rivets & RivNuts

PalNut Fasteners

Tinnerman

Dynacast

CamCar Textron

Pop Rivets

ITW Fastex

AVK Alternates

Truck Trailer & Truck Body Parts

Standard & Specialty Fasteners

Southco Fasteners

Huck Fastener

MKT/Gunnebo

Heyco Fasteners

Brasscraft

Gripco Fasteners

TRW Plastics

Ark-Les Terminals

Caplugs Corp

Castings

Stampings

Decals



Five Hi-Speed, Multi-Part Bagging Machines

- Up To Eight Automated Parts Per Bag
- Customized Polybags, Boxes and Labels
Large or Small runs

Samples of Engineered Components Products
Including:

- Encapsulated-Molded Polyseal
- FRP Composite Plate Compatible Mating Screws
- Tamperproof Bolts and Nuts

4000 HOUR SALT SPRAY PLATING AVAILABLE FOR ALL METAL PARTS

- Tested to last 4000+ hours
Also, 6,000 Hour Salt Spray being tested,
in-house with state-of-the-art
Salt Spray Cabinets
- Custom Graphics and Decals
- Custom Printing
- Customized polybags and labels. Large or
small runs



Tinker Box

**CONTACT US FOR FREE
TINKER BOX, SAMPLES
OR CATALOG**



Take a video tour at: www.engcomponents.com



Engineered Components Company

1100 Davis Road, Elgin, IL 60123

Phone: 847-841-7000 • Fax: 847-841-7007

e-mail: sales@engcomponents.com

HIGH SPEED POLY BAGGING EQUIPMENT

Engineered Components COMPANY



**Engineering Resources
to Reduce Cost**



**Pyramid Quality
Laboratory**



1100 Davis Road
Elgin Illinois, 60123
Phone: 847-841-7000
Fax: 847-841-7007



visit our web site for a video tour
www.engcomponents.com

NEW Equipment

1100 Davis Road, Elgin Illinois, 60123
Phone: 847-841-7000 • Fax: 847-841-7007
www.engcomponents.com

**Engineered
Components**
COMPANY



6 Die 6 Blow Heading Equipment
1/4" thru 1" Dia. Cold Formed • 1-1/8" thru 4" dia. Hot Formed

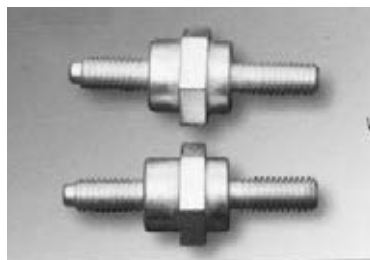

visit our web site for a video tour

www.engcomponents.com

MANUFACTURING RANGE

#2 thru 4"(inch) Diameter with Maximum Length 5'(feet)
Materials: Steel, Stainless, Aluminum



COMING
SOON

7 Die
7 Blow Equipment



**Engineered
Components**
COMPANY

1100 Davis Road
Elgin Illinois, 60123
Phone: 847-841-7000
Fax: 847-841-7007

*If someone says it can't be done.
Send it to US!*



visit our web site for a video tour

www.engcomponents.com

Engineered Components COMPANY

NEW COST SAVING PRODUCTS FROM CHINA



Trailer Couplers & Misc. Stampings



Wire Forms-Welded-Assembled



Screw Machine & Zinc Dycast Specials



Pulleys, Wheels, & Special Stampings

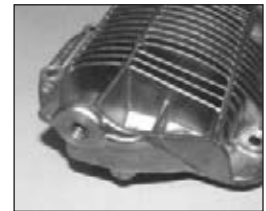

Forgings, Castings, Assemblies



Stampings-Assemblies

1100 Davis Road
Elgin Illinois, 60123
Phone: 847-841-7000
Fax: 847-841-7007



REGISTERED TO
ISO 9001 : 2000
FILE# A2691 U.S.

visit our web site for a video tour

www.engcomponents.com

TIRE AIR VALVES

**Engineered
Components**
COMPANY



1100 Davis Road
Elgin Illinois, 60123
Phone: 847-841-7000
Fax: 847-841-7007



REGISTERED TO
ISO 9001 : 2000
FILE# A2691 U.S.

visit our web site for a video tour

www.engcomponents.com

Engineered Components

COMPANY

TRAILER HARDWARE CARGO, UTILITY, DUMP



*Pipe Mount
Jacks*



Door Hinges



Jack Feet

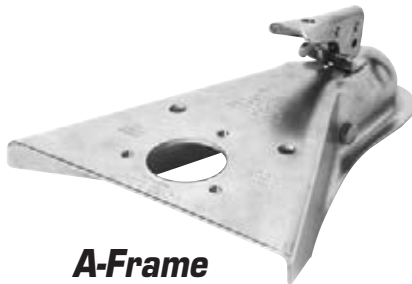

*A-Frame
Couplers*

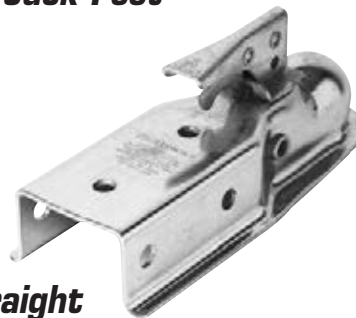

*Straight
Couplers*



*A-Frame
Jacks*

1100 Davis Road
Elgin Illinois, 60123
Phone: 847-841-7000
Fax: 847-841-7007



REGISTERED TO
ISO 9001 : 2000
FILE# A2691 U.S.



*Door
Hold Backs*



Bumpers



*Miscellaneous
Pins*

visit our web site for a video tour

www.engcomponents.com

CASTINGS

ALUMINUM
STAINLESS STEEL
COPPER • BRASS
ZINC • STEEL

Engineered Components

COMPANY



1100 Davis Road
Elgin Illinois, 60123
Phone: 847-841-7000
Fax: 847-841-7007



REGISTERED TO
ISO 9001 : 2000
FILE# A2691 U.S.

visit our web site for a video tour

www.engcomponents.com

Engineered Components COMPANY

1100 Davis Road
Elgin Illinois, 60123
Phone: 847-841-7000
Fax: 847-841-7007



REGISTERED TO
ISO 9001 : 2000
FILE# A2691 U.S.

ALUMINUM • STAINLESS STEEL
COPPER • BRASS • ZINC • STEEL

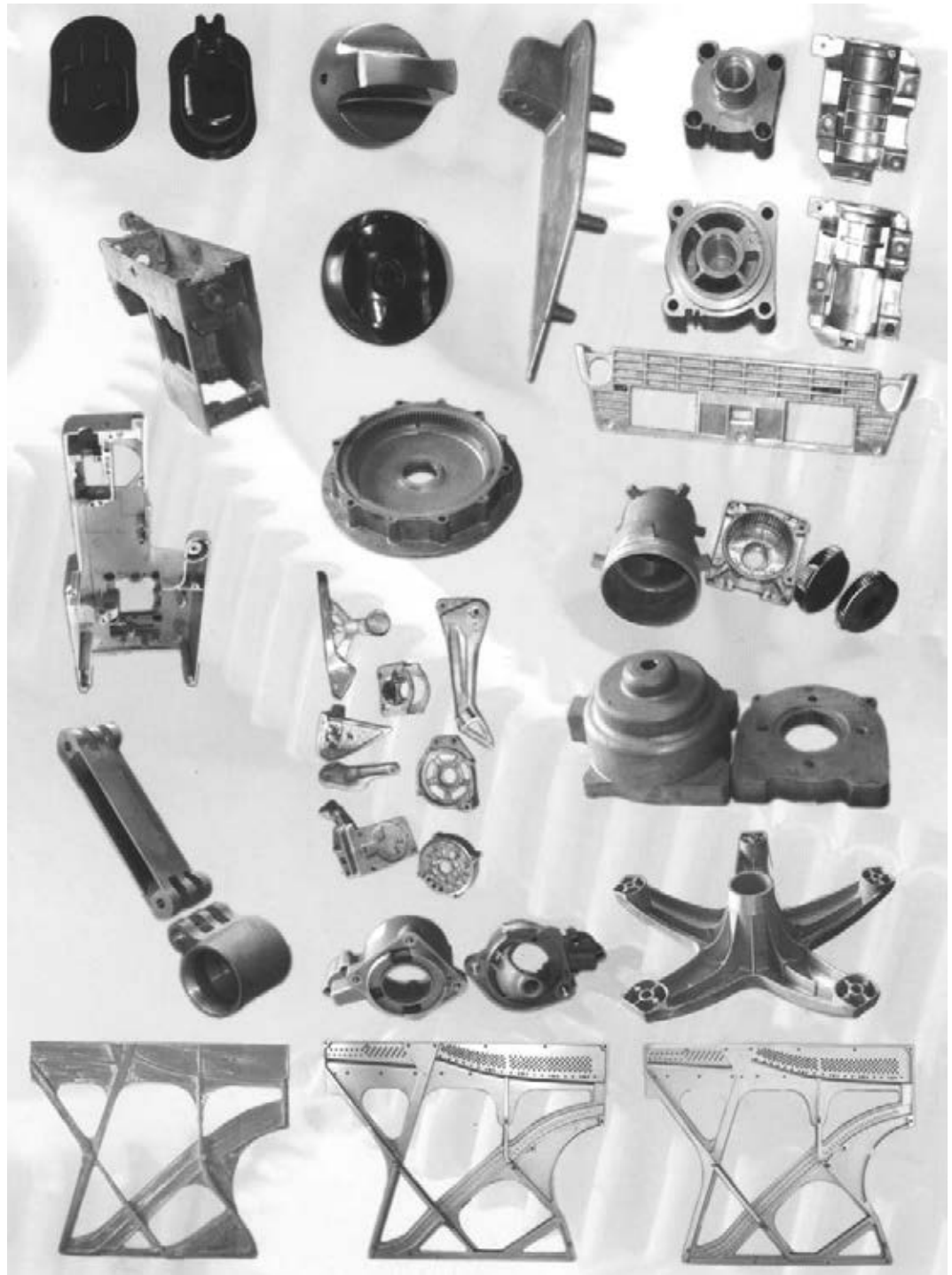

visit our web site for a video tour

www.engcomponents.com

FORGINGS

ALUMINUM STAINLESS STEEL COPPER • BRASS



Engineered Components

COMPANY

1100 Davis Road
Elgin Illinois, 60123
Phone: 847-841-7000
Fax: 847-841-7007



REGISTERED TO
ISO 9001 : 2000
FILE# A2691 U.S.

visit our web site for a video tour

www.engcomponents.com

Engineered Components COMPANY

1100 Davis Road
Elgin Illinois, 60123
Phone: 847-841-7000
Fax: 847-841-7007



REGISTERED TO
ISO 9001 : 2000
FILE# A2691 U.S.

ROD ENDS HEIM JOINTS

Rod Ends Technology Specification:

- Hardness of steel ball is about 58~64 HRC, it rotates freely and out bearing does not loosen.
- Hardness of linkage body is modulated to 20-24 HRC.
- The linkage body and thread surface is free from fraction, corrosion rust and other forging imperfection.



Heim Joints

Technology Specification:

- Round smoothly with stagnation.
- Ball clearance: axial straight angle direction 0.025~0.065 mm, axial clearance ≤ 0.3 mm
- Thread precision: Grade 6H
- Ball shaft: steel 40Cr.
- Ball housing: 45# steel.



visit our web site for a video tour

www.engcomponents.com

TRANSMISSION LINKAGE STAMPING CASTINGS

Engineered Components

COMPANY

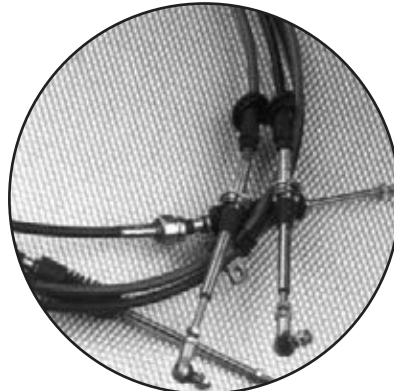
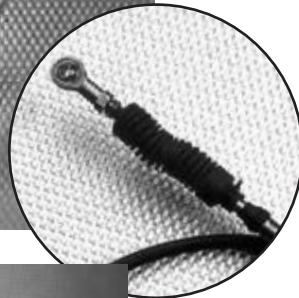
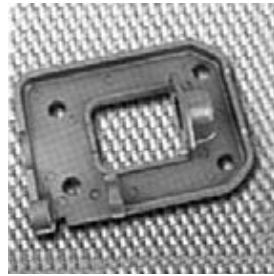

1100 Davis Road
Elgin Illinois, 60123
Phone: 847-841-7000
Fax: 847-841-7007



REGISTERED TO
ISO 9001 : 2000
FILE# A2691 U.S.

visit our web site for a video tour

www.engcomponents.com

Engineered Components

COMPANY

1100 Davis Road
Elgin Illinois, 60123
Phone: 847-841-7000
Fax: 847-841-7007



REGISTERED TO
ISO 9001 : 2000
FILE# A2691 U.S.

RETENTION COATING



The Advantages are Clear

- Can be applied to both threaded and unthreaded fasteners
- Temporarily holds fastener in place during fabrication, assembly, and transportation
- Positioning application only
- Soft enough to allow hand assembly
- Non-toxic, assembler friendly
- Environmentally friendly
- Provides a solution for robotics riveting type production
- Can be located at any point on fastener length
- Speeds assembly time
- Requires no additional features
- Cost effective
- Not affected by gasoline

Available in including colors
White, Green, Clear

visit our web site for a video tour

www.engcomponents.com

Engineered Components Company

All Fastener Products Related to Truck Trailer, Truck Body and Construction

- Floor Screws: Triple Lead, Single Lead, Type F
- Rib Neck Carriage Bolts: Grade 5
- Bottom Rail Bolts: Steel and Stainless Steel

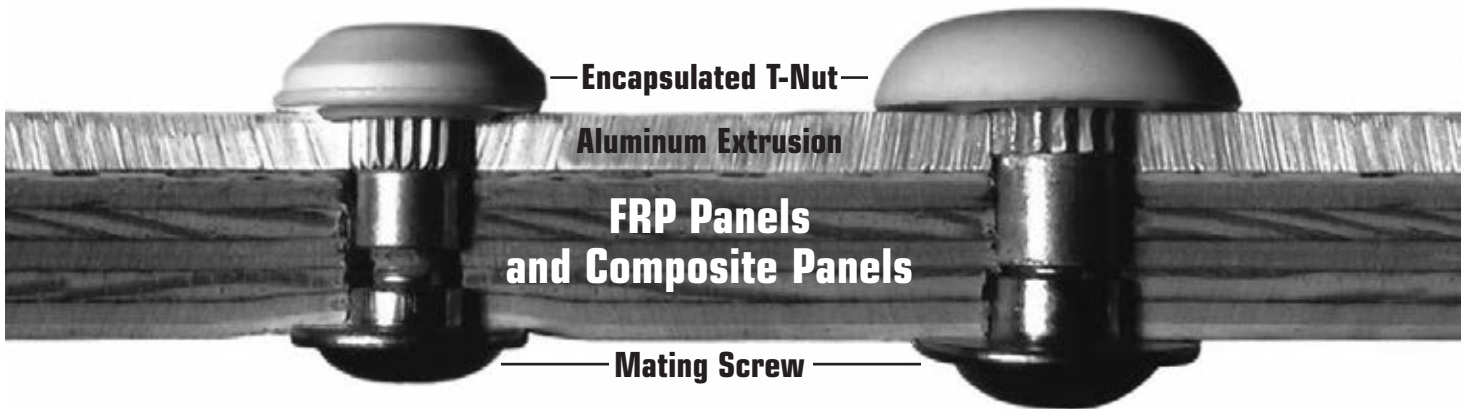

- Encapsulated T-Nuts: Truck Trailer, Truck Body, Pods & More
- Mating Screws: To Go With T-Nuts in All Various Grips
- Grip Range as low as 5/16"

**CONTACT US FOR FREE
TINKER BOX, SAMPLES OR
CATALOG**



Take a video tour at: www.engcomponents.com



Engineered Components Company
Engineered Components Company

1100 Davis Road, Elgin, IL 60123

Phone: 847-841-7000 • Fax: 847-841-7007

e-mail: sales@engcomponents.com



A2691US

AVK® Alternatives	51-53	Machine Screws	
Bolts		Torx® Flat Head Machine Screws	22
Rib Neck Grade-5.1 Carriage Bolt Zinc	24	Torx® or 6-Lobe Machine Screws	22-23
Exterior Stitching Fasteners	25	Torx® or 6-Lobe flat Head Steel	
Rear Door & FRP Assembly	27	Machine Screw Grade 2 – Plain	23
Step Bolt Grade 5	27	Serrated Hex Washer Flange Screws Grade-2 ...	39
Camtainer® Fastening System	29	Serrated Hex Washer Flange Screws Grade-5 ...	40
Bottom Rail Bolts & Nuts	31-33	Misc. Items	
Additional Bottom Rail Bolts & Misc. Items	32	2 Way Lock Nut Defection	45
M22 Wheel Bolt and Nut	38	UV Stabilized Black Wire Ties	49
FRP		Wire Ties	49
Closed End T-Nuts	13	Graphics	69
Poly Seal T-Nuts	13	Zip Lock Bags and Tape	71
Mating Screws	14-15	Electrical Tape	71
BTN Socket Wash Flange GR-8	22	Fab-Lok® Fasteners	91
FRP/Grip Range Chart	17-20	Nuts	
Encapsulated FRP Fastening System	18-20	Closed End T-Nuts	13
1/4 Truss Washer Head Mating Fasteners	19	Poly Seal T-Nuts	13
5/16 Truss Washer Head Mating Fasteners	20	M22 Wheel Bolts and Nuts	38
Dura Plate® or		Wheel Nuts (60°)	38
Thin Panel Polyseal T-Nut & Mating Screw	16	Wheel Nuts (60°) Grade 5	38
E-Track and FRP Blind Nuts	16	Rear Door & FRP Assembly	26-28
Rear Door & FRP Assembly	26-28	Camtainer® Fastening System	29
Camtainer® Fastening System	29	Bottom Rail Bolts & Nuts	31-33
Molded Head of Solid & Semi Tubular Rivets	21	Tamper Resistant Nuts	35
Plywood or Luwan Panels,		Serrated Hex Flange Nuts	41
Fiberglass and OSB Board	70	I.F.I. Grade-5 Nylon Insert	
Fastex® Alternatives		Lock Nuts .0005 Zinc & Clear	42
Christmas Tree clips and Ratchet Rivets	68	Grade-5 and Grade-8 2-Way Lock Nuts Zinc	43
Floorscrews/Thread Forming Screws		Flange Nuts No Serrations	44
1/4 Flat Head Torx® or		Twin Wiz Serrated Lock Nuts	44
6-Lobe Phos, Oil & Wax	1	Palnut Fasteners®	62-63
5/16 Flat Head Torx® or		PEM® Alternative	
6-Lobe Phos, Oil & Wax	1	Ultra-Sonic Sonic lock Brass Inserts	50
1/4 & 5/16 Torx® or		Self-Clinching Studs	54-55
6-Lobe Flat Floor Screws Zinc	3	Self-Clinching Nuts	56
1/4 & 5/16 Torx® or		Rear Door Hardware	
6-Lobe Pan Head Floor Screws		Rear Door & FRP Assembly	26-28
Zinc, Bake & Wax	4	Door Hold Back Hardware	27
Special and Replacement Floor Screw		Rear Door Hardware	
Thread Forming & Thread Cutting	6	(FRP Assembly and Repair)	26-28
Special floor Screws Thread Forming		Camtainer® Fastening System	29
and Thread Cutting	6	Light and Reflector Fasteners	35
Special floor Screws Thread Forming		Tamper Resistant Nuts	35
and Thread Cutting	7	Truck Bumpers	37
Repair kits			
Landing Gear	34		
Rear Door	34		
Bottom Rail	34		

Rivets

Aluminum Drive Rivet –Southco Alternate.....	36
Nylon Drive Rivet	
with Aluminum or Steel Pin	37
Ariel Pierce-&-Roll Self Pierce Rivet	60
Blind and Structural Rivets	61
Solid Aluminum Rivets	61
Composite Trailer Panel Blind Rivet	58

Works On:

Dura Plate®, P Series®, VXP®, Z Plate®

Self-Clinching Fasteners

Self-Clinching Studs	54-55
Self-Clinching Nuts	56

Self-Drilling Screws & Sheet Metal Screws

Economy Liner Screws	9
Stadler Liner & floor Screws	9
Torx® Plus Drilltite Wall-Liner Fasteners	10
Special Self-Drilling Screws	11
Self-Drilling Carbon Steel Fasteners	11
Additional Special Self Drilling Screws	11
Garage Door Screws	12
Square and Double Square Drive Screws	12

TRW® Fasteners..... 66-67**Threaded Insert Nuts**

Ultrasonic-Sonic lock Brass Inserts	50
AVK® Alternatives	51-53
JAK Nut Alternates & Well Nut Alternates.....	57
Rubber Nut Threaded Inserts	58
Rubber Nut Specification Sheet	59

Thread cutting Screws

1/4 & 5/16 Torx® or 6-Lobe Flat	
Type F TCS.....	2
1/4 & 5/16 Torx® or 6-Lobe Pan Head	
Type 23 TCS	4
Flat Phillips Type F TCS	5
Slotted Hex Washer "F" TCS Zinc	5
Unslotted Hex Washer Head	
Type F Zinc & Bake	5
Special Floor Screws Thread Forming and Thread Cutting	6
Special and Replacement Floor Screw Thread Forming & Thread Cutting	6
Additional Thread Cutting Screws.....	8
Special Floor Screws	

Thread Forming & Thread Cutting	7
---------------------------------------	---

Tinnerman® Fasteners 64-65**Torx® Plus**

Drilltite Wall-Liner Fasteners	10
Machine Screws	73-78
Stainless Steel Torx® Plus Machine Screws	79
Machine Screws With Crest Cup Washers	80
Taptite II Thread-Rolling Fasteners	81-85
Torx® Plus Plastite II	
Thread-Rolling Fasteners	86-89
Torx® Plus Plastite II	
Thread-Rolling Fasteners Stainless Steel	90

Trailer Brake Accessories

Eye Bolt W/Keps & Lock Nuts	46
Spring Plate	46
Trailer Brake Hose Springs.....	46
Brake Hose Separators	47
Hose Clip with Cable Tie Mount Assembly	48
Standard Beam clip Assemblies	48

Wheel Hardware

M22 Wheel Bolt & Nut	38
Wheel Nuts (60°)	38
Trailer Hub Heat Sensor Bolt.....	39

Technical Data

FRP/Grip Range Chart	17-20
Encapsulated FRP Fastening System	18-20
1/4 Truss Washer Head Mating Fasteners	19
5/16 Truss Washer Head Mating Fasteners	20
Special plating	30
Nicnut® Fastening System	16, 94

Hard To find Technical Data

Torque Tightening Guide	114-116
Recommended Hole Size for Thread Cutting Screws.....	117-119
Recommended Torque-Prevailing & Failure	120
Hole Size Wood Screw	121
Hole Size for Thread Forming Screws	122-123
Tensile Strength Break Load in Pounds #6 thru 1" dia	124
Torque Guide on SS Nuts	125
Self Drilling Screw Data	126

Phone: 847.841.7000 • Fax: 847.841.7007

web site: www.engcomponents.com

visit our web site for a video tour
www.engcomponents.com

1/4" FLAT HEAD TORX® OR 6-LOBE THREAD FORMING FLOOR SCREWS PHOS, OIL & WAX



SIZES AVAILABLE	PART #	500	1,000	2,500	5,000	10,000	25,000	50,000	100,000
1/4-20x1 (3500/ctn)	188917667-01F								
1/4-20x1-1/4 (3M/ctn)	188917687-01SL								
1/4-20x1-1/2 (3M/ctn)	188917707-01SL								
1/4-20x1-3/4 (1850/ctn)	188917727-01SL								
1/4-20x2 (2M/ctn)	188917747-01SL								
1/4-20x2-1/4 (1500/ctn)	188917767-01SL								
1/4-20x2-1/2 (1200/ctn)	188917787-01SL								
1/4-20x3 (1M/ctn)	188917817-01SL								
1/4-20x3-1/2 (900/ctn)	188917857-01SL								
1/4-20x4 (700/ctn)	188917897-01SL								
1/4-20x5 (350/ctn)	188917927-01SL								
1/4-20x6 (300/ctn)	188917937-01SL								



5/16" FLAT HEAD TORX® OR 6-LOBE THREAD FORMING FLOOR SCREWS PHOS, OIL & WAX

**OVER 100 MILLION
 SOLD YEARLY**

SIZES AVAILABLE	PART #	500	1,000	2,500	5,000	10,000	25,000	50,000	100,000
5/16-18x1(F)*	F9119667-01								
5/16-18x1-1/4 (2M/ctn)	188919687-01S								
5/16-18x1-1/2 (1800/ctn)	188919707-01SL								
5/16-18x1-3/4 (1450/ctn)	188919727-01SL								
5/16-18x2** Triple Lead (1250/ctn)	188919747-01TL								
5/16-18x2 Single Lead (1250/ctn)	188919747-01SL								
5/16-18x2-1/4 (1M/ctn)	188919767-01SL								
5/16-18x2-1/2 (1M/ctn)	188919787-01SL								
5/16-18x3 (750/ctn)	188919817-01SL								
5/16-18x3-1/2 (650/ctn)	188919857-01SL								
5/16-18x4 (500/ctn)	188919897-01SL								
5/16-18x4-3/4 (N/A)									
5/16-18x5 (350/ctn)	188919927-01SL								
5/16-18x6 (300/ctn)									
5/16-18x2-1/2 Truss (700/ctn)	188919785-01SL								

NOTE: All Floor Screws are Torx® /6-Lobe Flat Head Phos and Oil (other finishes available Zinc and Cad)
 2" and 2-1/4" are available in single lead and triple lead

* (F) Type F Thread cutting ** This item can be roll sorted for automatic feed equipment SL Single
 Lead Thread same as type F

\$25.00 Line Minimum \$50.00 Order Minimum Torx® is a Trademark of Camcar Div of Textron
 Triple Lead is patented by ECC pat.#5964560

Engineered Components

847-841-7000 • Fax 847-841-7007

TYPE "F" FLAT HEAD THREAD CUTTING FLOOR SCREWS *Phos & OIL*

***Popular for repairing trailer and truck body floors**

SIZES AVAILABLE	PART #	500	1,000	2,500	5,000	10,000	25,000	50,000
1/4-20x1	188917667-01F							
1/4-20x1-1/4	188917687-01F							
1/4-20x1-1/2	188917707-01F							
1/4-20x2	188917747-01F							
1/4-20x2-1/4	188917767-01F							
1/4-20x2-1/2	188917787-01F							
1/4-20x3	188917817-01F							
1/4-20x3-1/2	188917857-01F							
1/4-20x4	188917897-01F							
1/4-20x5	188917927-01F							
1/4-20x6	188917937-01F							
5/16-18x1-1/4	F9119667-01F							
5/16-18x1-1/2	188919707-01F							
5/16-18x2	188919747-01F							
5/16-18x2-1/4	188919767-01F							
5/16-18x2-1/2	188919787-01F							
5/16-18x3**	188919817-01F							

**For 5/16 diameter lengths over 3", we stock Tri-Lobular T.F.S. up to 6 inches long. See page 2 of our catalog for pricing.

Type "F" screws drive better than T.F.S. in repair application due to rust on the beams. The type "F" flute removes the rust from the threads as it is being driven, which prevents the fastener from binding and breaking.

Engineered Components

visit our web site for a video tour
www.engcomponents.com

1/4" TORX® OR 6-LOBE FLAT HD FLOOR SCREWS ZINC, BAKE & WAX



SIZES AVAILABLE	PART #	500	1,000	2,500	5,000	10,000
1/4-20x1 (3M/ctn)	188917667-06SL					
1/4-20x1-1/4 (3M/ctn)	188917687-06SL					
1/4-20x1-1/2 (3M/ctn)	188917707-06SL					
1/4-20x1-3/4 (3M/ctn)	188917727-06SL					
1/4-20x2 (2M/ctn)	188917747-06SL					
1/4-20x2-1/4 (1500/ctn)	188917767-06SL					
1/4-20x2-1/2 (1500/ctn)	188917787-06SL					
1/4-20x3 (1M/ctn)	188917817-06SL					
1/4-20x3-1/2 (900/ctn)	188917857-06SL					
1/4-20x4 (700/ctn)	188917897-06SL					
1/4-20x5 (350/ctn)	188917927-06SL					
1/4-20x6 (300/ctn)	188917937-06SL					

All 1/4-20 Floor Screws are Single Lead (Same Thread as a Type F)

OVER 100 MILLION SOLD YEARLY

5/16" TORX® OR 6-LOBE FLAT HEAD FLOOR SCREWS Zinc, Bake & Wax

SIZES AVAILABLE	PART #	500	1,000	2,500	5,000	10,000
5/16-18x1	F9119667-06					
5/16-18x1-1/4 (2M/ctn)	188919687-06SL					
5/16-18x1-1/2 (1800/ctn)	188919707-06SL					
5/16-18x1-3/4 (1450/ctn)	188919727-06SL					
5/16-18x2 TRIPLE LEAD (1250/ctn)	188919747-06TL					
5/16-18x2 SINGLE LEAD (1250/ctn)	188919747-06SL					
5/16-18x2-1/4 (1M/ctn)	188919767-06SL					
5/16-18x2-1/2 (1M/ctn)	188919787-06SL					
5/16-18x3 (750/ctn)	188919817-06SL					
5/16-18x3-1/2 (650/ctn)	188919857-06SL					
5/16-18x4 (500/ctn)	188919897-06SL					
5/16-18x4-3/4 (N/A)	188919997-06SL					
5/16-18x5 (350/ctn)	188919927-06SL					
5/16-18x6 (300/ctn)	188919937-06SL					
5/16-18x2-1/2 TRUSS (700/ctn)	188919785-06SL					

OVER 100 MILLION SOLD YEARLY

Floor Screws are Torx® /6-Lobe Flat Head TFS Zinc & Bake
 \$25.00 Line Minimum \$50.00 Order Minimum
 Torx® is a Trademark of Camcar Div of Textron

Engineered Components

847-841-7000 • Fax 847-841-7007

1/4 & 5/16 TORX® OR 6-LOBE PAN HEAD THREAD FORMING FLOOR SCREWS ZINC, BAKE & WAX



SIZES AVAILABLE	PART #	500	1,000	2,500	5,000	10,000	25,000	50,000
1/4-20x3/4	198917504-0682S							
1/4-20x1	198917664-0682S							
1/4-20x1-1/4	198917684-0682S							
1/4-20x1-1/2	198917704-0682S							
1/4-20x2	198917744-0682S							
1/4-20x4	198917894-0682S							
5/16-18x1	198919664-0682S							
5/16-18x1-1/4	198919684-0682S							
5/16-18x1-1/2	198919704-0682S							
5/16-18x2	198919744-0682S							
5/16-18x2-1/2	198919784-0682S							
5/16-18x3	198919814-0682S							
5/16-18x3-1/2	198919854-0682S							
5/16-18x4	198919894-0682S							
5/16-18x4-1/2	198919914-0682S							
5/16-18x5	198919924-0682S							
5/16-18x6	198919934-0682S							

All are Torx® or 6-Lobe Pan STL TFS Zinc, Bake & Wax \$25.00 Line Minimum \$50.00 Order Minimum
Torx® is a Trademark of Camcar Div. of Textron SL – Single Lead same as type F

LGE. QTY. Priced on application

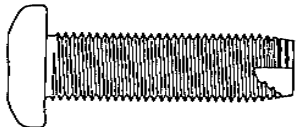

1/4 & 5/16 TORX® OR 6-LOBE PAN HEAD TYPE 23 THREAD CUTTING SCREWS

SIZES AVAILABLE	PART #	500	1,000	2,500	5,000	LGE. QTY. Priced on application	
		Torx® /6-Lobe Pan Head Type 23 TCS Zinc & Yellow & Wax					
1/4-20x1	F9117664-0782						
1/4-20x1-1/2	F9117704-0782						
1/4-20x2	F9117744-0782						
1/4-20x2-1/2	F9117784-0782						
1/4-20x3	F9117814-0782						
1/4-20x3-1/2	F9117854-0782						
Torx® /6-Lobe Pan Head Type 23 TCS PHOS OIL & WAX							
		500	1,000	2,500	5,000	10,000	25,000
5/16-18x1	F9119664-0182						
5/16-18x1-1/4	F9019684-0199						

\$25.00 Line Minimum \$50.00 Order Minimum Torx® is a Trademark of Camcar Div of Textron

Engineered Components

visit our web site for a video tour
www.engcomponents.com

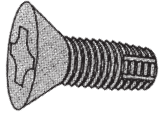

FLAT PHILLIPS TYPE F TCS Hardened, Zinc & Baked

SIZES AVAILABLE	PART#	500	1,000	2,500	5,000	10,000	25,000
1/4-20x1	F3217667-06						
1/4-20x1-1/4	F2917687-06						
1/4-20x1-1/2	F2917707-06						
1/4-20x2	F2917747-06						
1/4-20x2-1/4	F2917767-06						
1/4-20x2-1/2	F2917787-06						
1/4-20x3	F2917817-06						
1/4x20x3-1/2	F2917857-0682F						
1/4-20x4	F2917897-06						
1/4-20x5	F2917927-0682F						
1/4-20x6	F2917937-0682F						

UNSLOTTED HEX WASHER HEAD TYPE F ZINC & BAKE

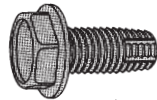

SIZES AVAILABLE	PART #	500	1,000	2,500	5,000	10,000	25,000
1/4-20x1/2	F2817343-06						
1/4-20x3/4	F2817503-06						
1/4-20x1	F2817663-06						
1/4-20x1-1/2	F2817703-06						
5/16-18x3/4	F2819503-06						
5/16-18x1	F2819663-06						
5/16-18x1-1/2	F2819703-06						
3/8-16x3/4	F2821503-06						
3/8-16x1	F2821663-06						
3/8-16x1-1/4	F2821683-06						
3/8-16x1-1/2	F2821703-06						

SLOTTED HEX WASHER "F" TCS Zinc

SIZES AVAILABLE	PART #	500	1,000	2,500	5,000	10,000	25,000
1/4-20 x 1/2							
1/4-20 x 3/4	F2717503-06						
1/4-20 x 1	F2717663-06						
1/4-20 x 1-1/4	F2717683-06						
1/4-20 x 1-1/2	F2717703-06						
1/4-20 x 2	F2717743-06						
1/4-20 x 3	F2717813-06						
5/16-18 x 3/4	F2719503-06						
5/16-18 x 1	F2719663-06						
5/16-18 x 1-1/4	F2719689-06						
5/16-18 x 1-1/2	F2719703-06						
3/8-16 x 3/4	F2721503-06						
3/8-16 x 1	F2721663-06						
3/8-16 x 1-1/4	F2721683-06						
3/8-16 x 1-1/2	F2721703-06						

Engineered Components

847-841-7000 • Fax 847-841-7007

SPECIAL FLOOR SCREWS T.F.S. & T.C.S.



PART #									
	500	1,000	2,500	5,000	10,000	25,000	50,000	100,000	250M+
1/4-20x2 Torx® or 6-Lobe Wafer Head TFS Phos, Oil and Wax									
F9117749-01TL									
16-10x2 Torx® or 6-Lobe Pan Head GR-5.1 TY-17 TCS 1-1/2 Thread Cad									
F8719744-02									
1/4-20x2-1/2 Torx® or 6-Lobe FLT T-40 Special Self Drilling Reamer Tek Zinc									
F8717789-06									
1/4-20x2-1/2 Torx® or 6-Lobe Wafer Head TCS Phos-Oil Wax									
F9117789-0IF									



SQUARE/PHILLIPS DRIVE FLAT HD TFS ZINC AND YELLOW & WAX NOSE LINER SELF TAPPING

SIZES AVAILABLE	PART #	1,000	2,000	5,000	10,000	25,000	50,000
1/4-20x1	F9917667-0782SL						

The above part can be used for nose plywood, liners, wood slats, tie rings...to name a few applications

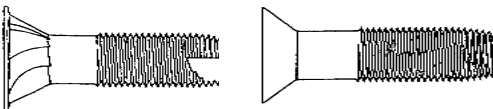

SPECIAL AND REPLACEMENT FLOOR SCREW T.F.S. AND T.C.S.

PART #	500	1,000	2,500	5,000	10,000	25,000	50,000
1 1/32x2-1/4 Torx® or 6-Lobe Flat Head TFS Phos, Oil, and Wax (oversize replacement)							
F8799767-0182							
1 1/32x2-1/4 Torx® or 6-Lobe Flat Self Countersinking Type 23 TCS Phos, Oil, and Wax (oversize replacement self countersinking with special tapping feature)							
F8999767-0182							
5/16-18x2-1/4 Torx® or 6-Lobe Flat Self Countersinking TFS Phos, Oil, and Wax (special countersinking)							
F9119767-0182							
1/2-20x2 Torx® or 6-Lobe Pan Head "F" TCS Cad							
F9026744-02							

\$25.00 Line Minimum \$50.00 Order Minimum
Torx® is a Trademark of Camcar Div. of Textron

**ASK FOR OUR FREE SAMPLE PACK
WITH 6 OF EACH PART**

Engineered Components

visit our web site for a video tour
www.engcomponents.com

SPECIAL FLOOR SCREWS T.F.S. & T.C.S.



PART #									
	500	1,000	2,500	5,000	10,000	25,000	50,000	100,000	250M+
5/16-18x1-3/4 Torx® or 6-Lobe Serrated Pan Head 23 GR-5 Cad, Wax, Lock Patch									
F9119729-0299IH (4037 IH)									
5/16-18x2-1/2 Torx® or 6-Lobe Flat Head 23 GR-5 TCS Phos and Oil									
F9119789-0199 (4037 IH)									
5/16-18x3 Torx® or 6-Lobe Button Head Undercut GR-5 "CA" Shank Slotted Phos, Oil and Wax									
188719819-0182C (4037 IH)									
5/16-18x2 Torx® or 6-Lobe Pan Head GR-8 TFS NIBS Under Head Zinc and Yellow and Bake									
F9119749-9027 (4037 IH)									



Torx® or /6-Lobe Pan Head TY-23 Zinc Yellow Bake and Stearic Wax							
SIZES AVAILABLE	PART #	500	1,000	2,500	5,000	10,000	25,000
1/4-20x1 (4037 IH)	F9117664-0782IH						
1/4-20x1-1/2 (4037 IH)	F9117704-0782IH						
1/4-20x2 (4037 IH)	F9117744-0782IH						
1/4-20x2-1/2 (4037 IH)	F9117784-0782IH						
1/4-20x3 (4037 IH)	F9117814-0782IH						
1/4x20x3-1/2 (4037 IH)	F9117854-0782IH						

ADDITIONAL THREAD CUTTING SCREWS

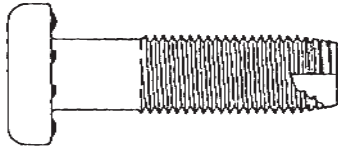

**11/32-18x1-3/4 6-LOBE PAN HD TYPE 23 TCS WITH NIBS
UNDERHEAD ZINC & YELLOW, WAX & INDUCTION HARDENED**

Replacement for 5/16-18 Fasteners Part # F9099729-0799IH

PART #	500	1,000	2,000	5,000	10,000	25,000	50,000



3/8-16x2 TORX OR 6-LOBE FLAT HD TYPE F TCS PHOS & OIL

Can be used for 5/16-18 replacement if 11/32 replacement not adequate

PART #	500	1,000	2,000	5,000	10,000	25,000	50,000



5/16-18x2-1/4 Slotted Flat Head Type TCS PHOS & OIL

PART #	500	1,000	2,000	5,000	10,000	25,000	50,000

Engineered Components

visit our web site for a video tour
www.engcomponents.com

ECONOMY SELF DRILLING LINER SCREWS

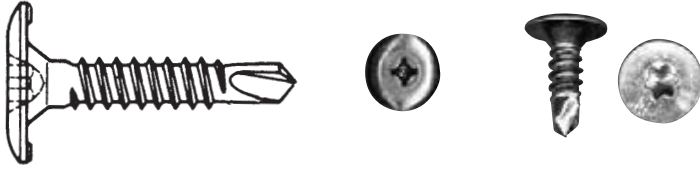

SIZES AVAILABLE	PART #	500	1,000	2,500	5,000	10,000	25,000	50,000	100,000
10-16x3/4 Combo Sq Phil Wafer Head With Serrations S/D ZY	71790-07T								
10-16x1 Combo Sq Phil Wafer Head With Serrations S/D ZY	400238-07T								
10-16x1-1/4 Combo Sq Phil Wafer Head With Serrations S/D ZY	400239-07T								
10-16x3/4 Torx® /6-Lobe Flat Wafer Head Self Drill Zinc	F8713508-06								
10-16x1 Torx® /6-Lobe Flat Wafer Head Self Drill Zinc	F8713668-06								
10-24x3/4 Phil Flat Wafer Head Self Drill Zinc	F3513508-06								
10-24x1 Phil Flat Wafer Head Self Drill Zinc	F3513669-06								
10-24x1-1/4 Phil Flat Wafer Head Self Drill Zinc	F3513688-06								
10-16x1 Sq Drive Flat Head Self Drill Zinc	F3466667-0682								

\$25.00 Line Minimum

\$50.00 Order Minimum

Torx® is a Trademark of Camcar Div of Textron

STADLER SELF DRILLING LINER & FLOOR SCREWS

Square/Phillips Combo Drive Flat Not Countersunk, Z & Y Wax

SIZES AVAILABLE	PART #	500	1,000	2,500	5,000	10,000	25,000	50,000	100,000
10x3/4	71790-07								
10x1	400238-07								
10x1-1/4	400239-07								

Torx® /6-Lobe Flat Head Countersunk With Wings, Zinc & Wax



SIZES AVAILABLE	PART #	500	1,000	2,500	5,000	10,000	25,000	50,000	100,000
1/4x1-3/4	425857-06						Available Upon Request		
1/4x2	425859-06								
1/4x2-3/8	400184-06								
1/4x2-3/4	425862-06								

Engineered Components

847-841-7000 • Fax 847-841-7007

TORX PLUS® DRILLITE® WALL-LINER FASTENERS



	ECC Part #	500	1,000	2,500	5,000	10,000	15,000	25,000	50,000	100,000
10-24 x 0.700 Torx Plus® Wafer Head	F8713499-07									
10-24 x 7/8 Torx Plus® Wafer Head	F8713589-07									
10-24 x 1 Torx Plus® Wafer Head	F8713669-07									
10-24 x 1-3/8 Torx Plus® Wafer Head	F8713699-07									
10-24 x 1-3/4 Torx Plus® Wafer Head	F8713729-07									

Specifications

Torx® is a Registered Trademark of Camcar Textron

- Sizes: #10
- Head Style: Wafer head with locking serrations
- Drive System: Torx Plus® Drive
- Thread Style: Round-body Taptite®
- Material: Low carbon steel
- Heat treat: Case hardened
- Plating: Zinc and yellow chromate

visit our web site for a video tour
www.engcomponents.com

SELF-DRILLING CARBON STEEL FASTENERS

Zinc Plated

1/4" Diameter Type 5 Point 3/8" Hex Washer Head

SIZE	Carton Quantity	ECC PART #	1,000	2,500	5,000	10,000	15,000	25,000
1/4-14 x 3	1m	EC1-DF3-5B988						
1/4-14 X 5	500	EC2-DF3-5B838						
1/4-14 X 6	250	EC3-DF3-5B839						
1/4-14 X 8	100	EC4-DF3-5C096						



ADDITIONAL SPECIAL SELF DRILLING SCREWS

PART #	500	1,000	2,500	5,000	10,000	25,000	50,000
12-14 x 1-1/4 Torx® or 6-lobe Wafer Head #3 Point .0003 Cad J.D. 5+ (4000Hr. Salt Spray)							
F8768689-98							
14-14 x 1-9/16 Torx® or 6-lobe Wafer Head #3 Point Zinc & Yellow							
F8717999-07							

PART #	1,000	2,500	5,000	10,000	25,000	50,000
11x5/8 flat HD Self Counter Sinking Liner self Drilling Screws Zinc Yellow						
11x7/16 Flat HD Self Counter Sinking Liner 'AB' SMS Zinc Yellow						

FOR USE IN PLASTIC, FIBRE GLASS OR COMPOSITE TRAILER AND TRUCK BODY LINERS

Engineered Components

847-841-7000 • Fax 847-841-7007

SELF DRILLING SCREWS



SQUARE AND DOUBLE SQUARE DRIVE SELF DRILLING SCREWS

SIZES AVAILABLE	PART #	1,000	5,000	10,000	25,000	50,000	100,000	250,000
		Square or Double Square Truss Head — Plain Finish						
10-16x1/2	F9966345-00							
10-16x3/4	F9966505-00							
10-16x1	F9966665-00							
Square or Double Square Truss Head — Cad Plating								
10-16 x 1/2	F9966345-02							
10-16x3/4	F9966505-02							
10-16x1	F9966665-02							
Square or Double Square Truss Head — .0003-.0005 Cad & J.D. #5+ (4000 Hours Salt Spray)								
10-16x1/2	F9966345-96							
10-16x3/4	F9966505-96							
10-16x1	F9966665-96							
Square or Double Square Truss Head — Plain Finish								
11-16x1/2	F9999345-00							
11-16x3/4	F9999505-00							
11-16x1	F9999665-00							
Square or Double Square Truss Head — Cad Plating								
11-16 x 1/2	F9999345-02							
11-16x3/4	F9999505-02							
11-16x1	F9999665-02							
Square or Double Square Truss Head — .0003-.0005 Cad & J.D. #5+ (4000 Hours Salt Spray)								
11-16x1/2	F9999345-96							
11-16x3/4	F9999505-96							
11-16x1	F9999665-96							

GARAGE DOOR SELF DRILLING SERRATED SCREWS

Hex Washer 7/16" Across Flats Zinc



SIZES AVAILABLE	PART#	500	1,000	2,500	5,000	10,000	25,000
1/4-20x5/8							
1/4-20x3/4	F3417503-06						

ADDITION SPECIAL SELF DRILLING SEE PAGE 00

Engineered Components

visit our web site for a video tour
www.engcomponents.com

POLY SEAL T-NUTS
 Encapsulated Grey or White
 Other Colors Available, Call for Pricing

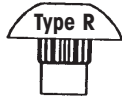
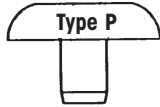
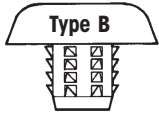

SIZES AVAILABLE	PART #	1,000	2,000	6,000	10,000	25,000	50,000	100,000	250,000	500M+
1/4-20x7/16 Ribbed T-Nut GR 5.1 Case Hardened Zinc (R)	F9917348-0201 F9917348-0707									
1/4-20 x 7/16 Long Ribbed (.350) T-Nut GR 5.1 Case Hard Z & Y (R)	F9917348-7501 F9917348-7507									
1/4-20x7/16 Plain Barrel T-Nut Zinc (P)	449217300-07 449217300-01									
1/4-20 x 5/16 Ribbed T-Nut GR 5.1 Case Hardened Zinc (R)	F9917209-0607 F9917209-0601									
5/16-18x1/2 Ribbed T-Nut GR 5.1 Case Hardened Zinc (R)	F9919348-1007 F9919348-1001									
5/16-18x7/16 Plain Barrel 1022 Steel T-Nut Zinc & Dich. (P)	44921930-01 449219309-07									
5/16-18x5/8 Plain Barrel 1022 Steel T-Nut Zinc & Dich. (P)	449219420-01 449219420-07									
5/16-18x7/16 GR-5.1 Barbed T-Nuts (B)	F9219309-9401									
5/16-18x1/2 449219340-01 Barbed T-Nuts (B)	449219340-07									

1/4-20x1/2 Barbed Available on Request, 1/4-20x7/16 Barbed Available on Request, 5/16-18x7/16 Barbed Available on Request
 All Prices Are Per Thousand \$25.00 Line Minimum \$50.00 Order Minimum



CLOSED END T-NUTS

**OTHER SIZES OF MOLDED T NUTS
 AVAILABLE UPON REQUEST**

SIZES AVAILABLE	PART #	500	1,000	2,500	5,000	10,000	25,000
5/16-18x7/16 T-NUT ZY NOT ENCAPED	44193099-07						
5/16-18x1/2 GR-5.1 RIB T-NUT CAD NOT ENCAPED	F9919348-02						
5/16-18x5/8 T-NUT ZY NOT ENCAPED	44194299-07						

Engineered Components

847-841-7000 • Fax 847-841-7007



MATING SCREWS

For Use With Molded T-Nuts or Other Stitching Applications

SIZES AVAILABLE	PART #								
		500	1,000	2,500	5,000	10,000	25,000	50,000	100,000
Torx® or 6-Lobe Truss Washer Head Zinc With Lock Patch									
1/4-20x7/16	F8717305-0692								
1/4-20x1/2	F8717349-06								
1/4-20x3/4	F8717509-06								
5/16-18x1/2	F8719349-0692								
5/16-18x3/4	F8719509-0692								
Torx® or 6-Lobe Truss Washer Head Zinc With Shoulder and Lock Patch									
1/4-20x1/2 (1/8 Shoulder)	F8717348-0692								
1/4-20x5/8 (1/8 Shoulder)	F8717428-0692								
1/4-20x3/4 (1/8 Shoulder)	F8717508-0692								
1/4-20x1 (1/8 Shoulder)	F8717668-0692								
5/16-18x1/2 (3/16 Shoulder)	F8719348-0692								
5/16-18x5/8 (3/16 Shoulder)	F8719428-0692								
5/16-18x3/4 (3/16 Shoulder)	F8719508-0692								
5/16-18x7/8 (3/16 Shoulder)	F8719588-0692								
5/16-18x1 (3/16 Shoulder)	F8719668-0692								
5/16-18x1-1/8 (3/16 Shoulder)	F8719678-0692								
5/16-18x1-1/4 (3/16 Shoulder)	F8719688-0692								
Misc. Torx® or 6-Lobe Mating Screws									
*1/4-20x11/16 (Small Button) Patch Zinc	F8717469-06								
*1/4-20x1 Truss GR-5.1 .0003min CA/JD5+	F8717665-96								
*5/16-18x1/2 (Truss) Patch Zinc	18871934-0699								
*5/16-18x3/4 (Truss) Patch Zinc	18871950-0699								
*5/16-18x15/16 GR5.1 (Button) Patch Zinc	F8719629-9692								
*5/16-18x1 BTN GR-5.1 UC Washer .0003min CA/JD 5+, Patch	F8719628-9692								
*5/16-18x1-3/8 Truss UC Washer CAD Patch	F8719699-02								

* Other Options May Be Available
P. O. A. = Priced on Application

\$25.00 Line Minimum \$50.00 Order Minimum
Torx® is a Trademark of Camcar Div of Textron

visit our web site for a video tour
www.engcomponents.com

FIBERGLASS REINFORCED PANEL

The FRP bolt has been designed to provide a low profile, large diameter head and radius fillet for an even pressure clamp load. The ribbed neck provides a lock into the hinge or FRP panel to prevent unwanted twisting.

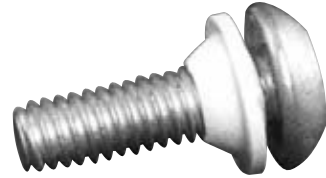
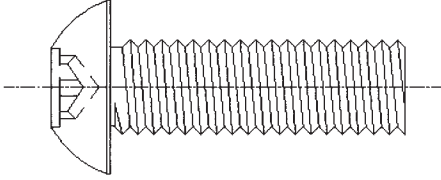

FRP Bolt– The FRP bolt has been designed to provide a low profile, large diameter head and radius fillet for an even pressure clamp load. The ribbed neck provides a lock into the hinge or FRP panel to prevent unwanted twisting.

Size	1/4	5/16	1/2	3/4	1	1-1/4	1-1/2	1-3/4	2	2-1/4	2-1/2	2-3/4	3
1/4													
5/16													
3/8													
1/2													

** Denotes items available upon request

Longer lengths and larger diameters may be available upon request

Engineered Components

847-841-7000 • Fax 847-841-7007

E-TRACK AND FRP BLIND NUTS

Nic Nut the Molded (Encapsulated) and Blind Rivet Alternative

Use Standard Blind Rivets or Structural Blind Rivets as a Mating Part

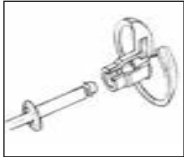

GRIP RANGE	1/4" BLIND OR STRUCTURAL RIVET
.490 -	.604 8-4
.532 -	.715 8-6
.642 -	.850 8-8
.755 -	.945 8-10
.865 -	1.057 8-12
.997 -	1.229 8-14
1.112 -	1.341 8-16

Hole Size: 13/32"

Dimensions:

Head Dia. 1-1/8"

Head Ht. .199"

Length Under Head .490"

*See page 88 for more specifications

DURA PLATE™ OR THIN PANEL POLYSEAL T-NUT & MATING SCREW

Encapsulated Grey or White Call For Pricing



SIZES AVAILABLE	PART #	500	1,000	2,500	5,000	10,000	25,000
1/4-20x7/16 Ribbed T-Nut GR 5.1 Modified Head Case Hardened Cad (R)	F9917349-0201m F8717349-0207m						
1/4-20x310/330 TR. Wash Undlt GR 5.1 Zinc LP	F8717300-0692						

visit our web site for a video tour
www.engcomponents.com

4 T-NUT STYLES WITH 5 MATING SCREW OPTIONS

The below grip ranges cover
our 1/4-20 ribbed t-nuts grade 5.1

	PART #	STANDARD	MODIFIED	STANDARD	MODIFIED
		1/4-20 x 7/16	1/4-20 x 7/16	1/4-20 x 5/16	1/4-20 x 5/16
1/4-20 Mating Screws		F9917348	F9917348 (M)	F9917209	F9917209 (M)
1/4-20x.260 (NS)	F8717999	.425 - .470	.360 - .400	.300 - .340	.199 - .275
1/4-20x.310/.330 (NS)	F8717300	.410 - .495	.350 - .420	.310 - .360	.250 - .320
1/4-20x.7/16 (NS)	F8717305	.435 - .600	.390 - .520	.400 - .490	.335 - .420
1/4-20x.1/2 (NS)	F8717349	.470 - .685	.445 - .615	.470 - .550	.435 - .480
1/4-20x1/2(S)	F8717348	.510 - .660	.450 - .580	.460 - .540	.390 - .480
1/4-20x.5/8 (S)	F8717428	.610 - .765	.585 - .725	.590 - .670	.515 - .600
1/4-20x.3/4 (S)	F8717508	.745 - .900	.725 - .850	.740 - .810	.670 - .730

The above grip ranges may vary slightly due to tolerances on both nut length, mold, and mating screws.

NS – NO SHOULDER

S – WITH SHOULDER

O6 – ZINC

O692 – ZINC WITH LOCK PATCH

M – MODIFIED

**SEVERAL OTHER SIZES OF MATING SCREWS ARE AVAILABLE TO FIT OTHER GRIPS.
THE SIX ABOVE ARE THE MOST WIDELY USED**

GRIP RANGES FROM .195 TO 2" PLUS

ENGINEERED COMPONENTS COMPANY

ENCAPSULATED FRP FASTENING SYSTEM

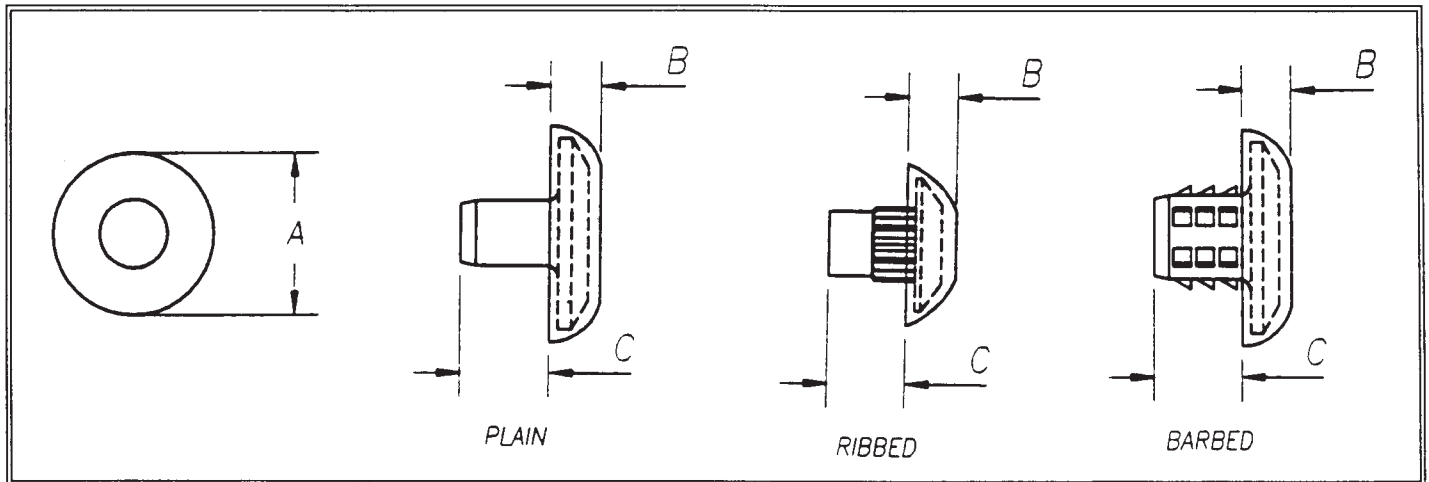

****ANY COLOR AVAILABLE ON ALL T-NUTS**

ECC PART NUMBER	THREAD SIZE	A	B	C	**STANDARD HEAD COLOR	NECK	HOLE SIZE
F9917348-0707	1/4-20	0.825	0.250	0.425	GRAY	RIBBED	Call For Recommended Hole Size
F9917348-14	1/4-20	0.825	0.250	0.425	PENSKE	RIBBED	
F9917348-08	1/4-20	0.825	0.250	0.425	RYDER	RIBBED	
F9917348-0201	1/4-20	0.825	0.250	0.425	WHITE	RIBBED	
F9919348-1007	5/16-18	1.100	0.258	0.455	GRAY	RIBBED	
449219340-14	5/16-18	1.100	0.258	0.455	PENSKE	BARBED	
449219340-08	5/16-18	1.100	0.258	0.455	RYDER	BARBED	
449219340-01	5/16-18	1.100	0.258	0.455	WHITE	BARBED	
F9219309-9401	5/16-18	1.100	0.258	0.405	WHITE	BARBED	
449219420-07	5/16-18	1.100	0.258	0.625	GRAY	PLAIN	
449219309-07	5/16-18	1.100	0.258	0.438	GRAY	PLAIN	

CAP: INJECTION MOLDED WITH VIRGIN POLY MATERIAL

FINISH:
 1/4-20 RIBBED CAD
 5/16-18 BARBED ZINC DYCAST
 5/16-18 PLAIN BARREL ZINC & YELLOW

ENGINEERED COMPONENTS COMPANY

TRUSS WASHER HEAD MATING FASTENERS FOR FRP FASTENING SYSTEMS

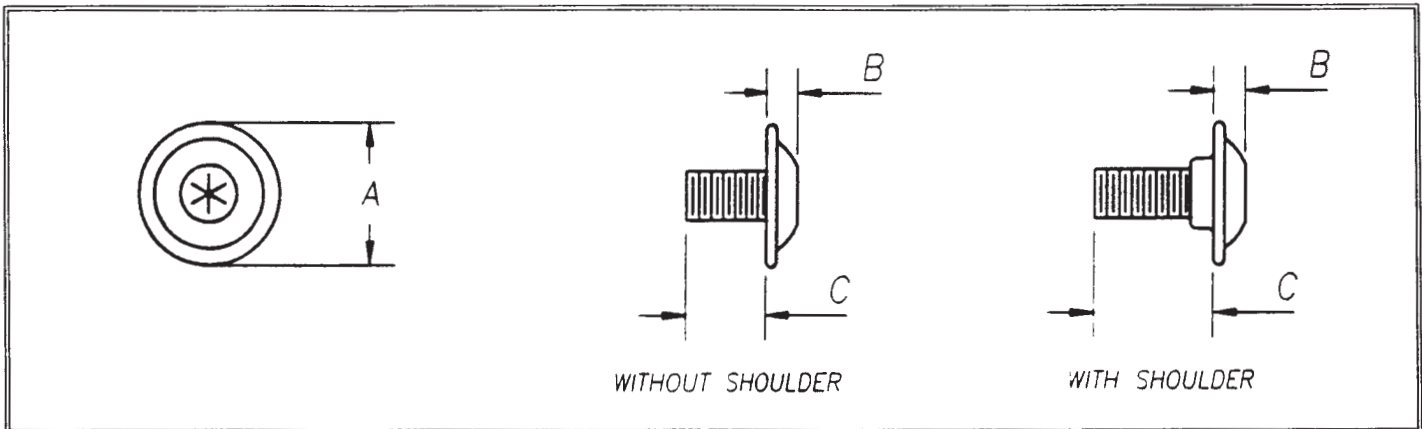

ECC PART NUMBER	THREAD SIZE	THREAD			LOCK	
		A	B	C	PATCH COLOR	SHOULDER
F8717305-0692	1/4-20	0.725	0.165	.407-.437	NATURAL	NO
F8717349-06	1/4-20	0.725	0.165	.470-.500	YELLOW	NO
F8717348-0692	1/4-20	0.725	0.165	.470-.500	YELLOW	YES
F8717428-0692	1/4-20	0.725	0.165	.595-.625	GREEN	YES
F8717508-0692	1/4-20	0.725	0.165	.720-.750	BLUE	YES
F8717668-0692	1/4-20	0.725	0.165	.845-.875	YELLOW	YES

FINISH: ZINC

LOCK PATCH: 3M OR EQ. MICRO ENCAPSULATED

ENGINEERED COMPONENTS COMPANY

TRUSS WASHER HEAD MATING FASTENERS FOR FRP FASTENING SYSTEM

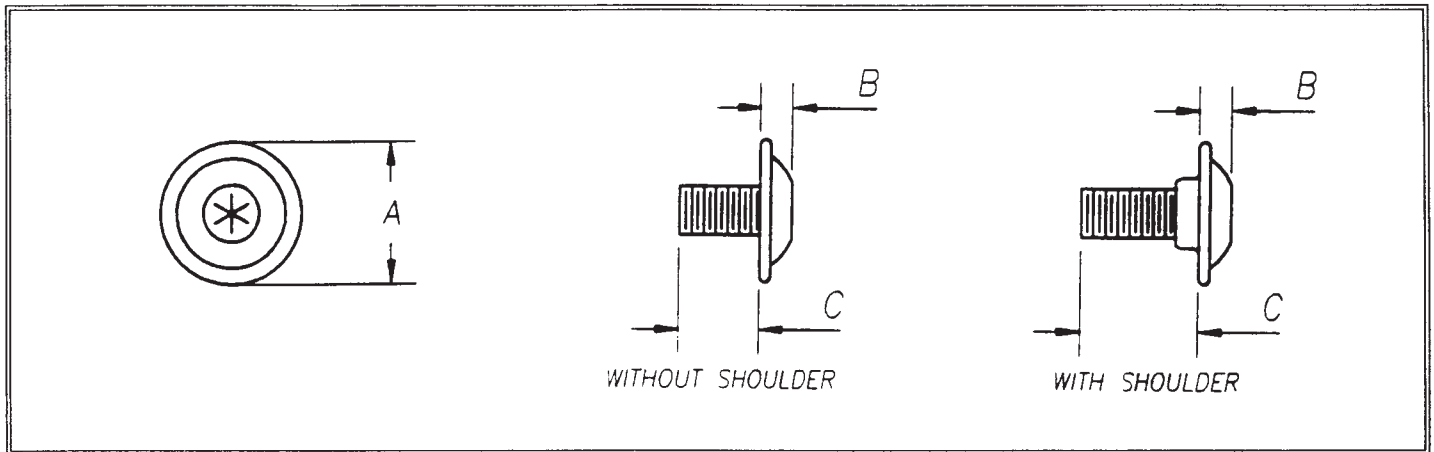

ECC PART NUMBER	THREAD SIZE	A	B	C	LOCK	
					PATCH COLOR	SHOULDER
F8719305-0692	5/16-18	0.870	0.188	7/16	BLUE	NO
F8719349-0692	5/16-18	0.870	0.188	.500-.530	YELLOW	NO
F8719428-0692	5/16-18	0.870	0.188	.595-.625	GREEN	YES
F8719508-06	5/16-18	0.870	0.188	.720-.750	BLUE	YES
F8719588-0692	5/16-18	0.870	0.188	.845-.875	YELLOW	YES
F8719668-0692	5/16-18	0.870	0.188	.950-1.000	GREEN	YES
F8719678-0692	5/16-18	0.870	0.188	1.075-1.125	BLUE	YES

FINISH: ZINC

LOCK PATCH: 3M OR EQ. MICRO ENCAPSULATED

visit our web site for a video tour
www.engcomponents.com

MOLDED ENCAPSULATED HEAD OF SOLID AND SEMI-TUBULAR RIVETS

We take standard parts and put an encapsulated head on it for protection and appearance.



ADVANTAGES

- Head will not rust
- Half the price of stainless steel
- Steel is much easier to set (roll over)
- Better appearance
- Available in any color to match your application
- On steel parts we can also add high corrosion platings up to 10,000 hours of salt spray

MOLDED ENCAPSULATED HEAD MALE AND FEMALE RIVETING SYSTEM

We take standard two piece riveting system and encapsulate the tubular rivet.



NOM. RIVET DIAM.	HOLE SIZE	BLIND RIVET				TUBULAR		
		S MAND. DIAM.	D1 RIVET DIAM.	A1 HEAD DIAM.	B1 HEAD THICK	D1 RIVET DIAM.	A1 HEAD DIAM.	B1 HEAD THICK
3/16"	0.25	0.076	0.125	0.375	0.059	0.188	0.375	0.057
1/4"	0.312	0.114	0.187	0.625	0.095	0.25	0.625	0.095

AVAILABLE IN ANY COLOR

GRIP RANGES FROM 5/8" TO 4"

RIVETS

- Alum./Alum.
- Steel/Steel
- Alum./Steel

TUBULAR COMPONENTS

- Aluminum or Steel

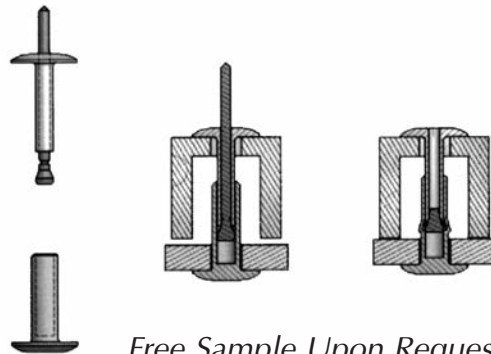

Free Sample Upon Request

Engineered Components

847-841-7000 • Fax 847-841-7007

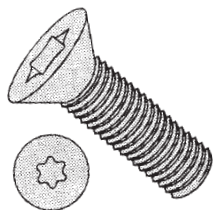

TORX® FLAT HEAD MACHINE SCREWS

Alloy Steel Heat Treated Class 3A

REFERENCE#	T-45 DRIVE
09543	3/8-16x1/2
39543	3/8-16x5/8
69543	3/8-16x3/4
20643	3/8-16x1
50643	3/8-16x1-1/4
80643	3/8-16x1-1/2
11643	3/8-16x1-3/4
41643	3/8-16x2
71643	3/8-16x2-1/4
02643	3/8-16x2-1/2
62643	3/8-16x3

REFERENCE#	T-50 DRIVE
35643	1/2-13x3/4
26643	1/2-13x1
56643	1/2-13x1-1/4
86643	1/2-13x1-1/2
17643	1/2-13x1-3/4
47643	1/2-13x2
77643	1/2-13x2-1/4
08643	1/2-13x2-1/2
68643	1/2-13x3

Other sizes available from #2 thru 3/4 N.C. and N.F.
Torx® is a Registered Trademark of Camcar Textron



BUTTON SOCKET WASHER FLANGE GR-8 PLAIN

Can be used for mating screw on molded or unmolded T-Nuts 1/4 and 5/16-18

SIZES AVAILABLE	500	1,000	2,500	5,000	10,000	25,000
1/4-20x3/8						
1/4-20x1/2						
1/4-20x3/4						
1/4-20x1						
5/16-18x3/8						
5/16-18x1/2						
5/16-18x5/8						
5/16-18x3/4						
5/16-18x1						
3/8-16x1/2						
3/8-16x3/4						
3/8-16x1						
3/8-16x1-1/4						

The 3/8-16 parts can be used as bottom rail bolts or be used with T-nuts or lock nuts for various applications

Flat Head Grade 2 Zinc

Size	Part #	500	1,000	2,500	5,000	10,000	25,000
1/4-20 x 3/4	F8717507-06						
1/4-20 x 1	F8717667-06						
1/4-20 x 1-1/4	F8717687-06						
1/4-20 x 1-1/2	F8717707-06						
1/4-20 x 1-3/4	F8717727-06						
1/4-20 x 2	F8717747-06						

Pan Head Grade 2 Zinc

Size	Part #	500	1,000	2,500	5,000	10,000	25,000
1/4-20 x 3/4	F8717508-06						
1/4-20 x 1	F8717688-06						
1/4-20 x 1-1/4	F8717684-06						
1/4-20 x 1-1/2	F8717704-06						
1/4-20 x 1-3/4	F8717724-06						
1/4-20 x 2	F8717744-06						

Flat Head Grade 8 Plain

Size	Part #	500	1,000	2,500	5,000	10,000	25,000
1/4-20 x 3/8	EC-34506						
1/4-20 x 1/2	EC-34509						
1/4-20 X 5/8	EC-34515						
1/4-20 X 3/4	EC-34518						
1/4-20 X 1	EC-34524						
1/4-20 X 1-1/2	EC-34530						
1/4-20 X 1-3/4	EC-34533						
1/4-20 X 2	EC-34536						
5/16-18 X 1/2	EC-34548						
5/16-18 X 5/8	EC-34554						
5/16-18 X 3/4	EC-34557						
5/16-18 X 1	EC-34563						
5/16-18 X 1-1/4	EC-34566						
5/16-18 X 1-1/2	EC-34572						
5/16-18 X 2	EC-34578						

Engineered Components

visit our web site for a video tour
www.engcomponents.com

**RIB NECK GR-5.1
 CARRIAGE BOLT ZINC**
 Ribneck Head can be molded

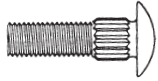

SIZES AVAILABLE	PART #	500	1,000	2,500	5,000	10,000	25,000
1/4-20x3/4	F6717500-06						
1/4-20x1	F6717660-06						
1/4-20x1-1/4	F6717680-06						
1/4-20x1-1/2	F6717700-06						
1/4-20x1-3/4	F6717720-06						
1/4-20x2	F6717740-06						
5/16-18x1	F6719660-06						
5/16-18x1-1/4	F6719680-06						
5/16-18x1-1/2	F6719700-06						
5/16-18x1-3/4	F6719720-06						
5/16-18x2	F6719740-06						
5/16-18x2-1/2	F6719780-06						
5/16-18x3	F6719810-06						
3/8-16x1-1/4 .375 Rib	F6721681-06						
3/8-16x1-1/2	F6721700-0688						
3/8-16x1-3/4	F6721720-06						
3/8-16x2	F6721740-06						
3/8-16x2-1/2	F6721780-06						
3/8-16x3	F6721810-06						

\$25.00 Line Minimum \$50.00 Order Minimum
 Rib Neck T-Nuts are a Patented Item

EXTERIOR STITCHING FASTENERS

For Truck Trailers, Truck bodies,
Tag-A-Longs, Container, Utility & Rental Trailers

SIZES AVAILABLE	PART #									
		500	1,000	2,500	5,000	10,000	25,000	50,000	100,000	
Torx® or 6-Lobe Undercut Pan Head With Sealing Washer, Lock Patch and Cad										
1/4-20x1/2	F8717349-0198									
1/4-20x7/8	F8717589-0198									
1/4-20x1 1/16	F8717469-0198									
1/4-20x1-1/4	F8717689-0198									
1/4-20x1-5/8	F8717719-0198									
T-Nuts Zinc (Mating Parts for Above Fasteners)										
1/4-20x7/16	F0817307-06									
1/4-20x1/2	F0817347-06									
1/4-20x5/8	F0817427-06									
Torx® or 6-Lobe Undercut Button Head with Sealing Washer, Lock Patch and Cad										
5/16-18x3/4	F8719509-9692									
5/16-18x15/16†	F8719629-969287									
5/16-18x1	F8719628-9692									
5/16-18x1-3/8	F8719699-02									
T-Nuts (Trailer Nuts) Zinc Mating Parts for Above Fasteners										
5/16-18x3/8 Weld Nut (With Nibs)	F0819240-06									
5/16-18x5/8 (Undercut)	F0819429-06									
Torx® or 6-Lobe Large 3/4" Dia Truss Head Undercut with O-Ring, Lock Patch and Cad										
1/4-20x1 1/16	F8717465-0398									
1/4-20x1-5/8	F8717715-0398									
Hex Washer Head 3/8" Full Body Shoulder with Sealing Washer or Plastisol, Lock Patch and Cad Plating										
5/16-18x3/4	F1819509-9692									
5/16-18x1	F1819669-9692									
5/16-18x1-1/4	F1819689-9692									
Hex Washer Flange Head GR-5.1, No Shoulder with Sealing Washer and Cad Plating										
5/16-18x3/4*	F1119509-96									
Torx® or 6-Lobe Button HD Undercut with Sealer 0003 min. Cad and J.D.										
3/8-16x1	F8721665-9892									
Torx® or 6-Lobe Truss undercut with O ring Seal 18-8 stainless										
5/16-18x3/4*	F8719509-19									
Torx® or 6-Lobe Truss Hd Gr 5.1 Ms .003 Cad J.D. 5+ (4000 Hr Salt Spray)										
1/4-20x1	F8717665-96									

(EQ to Corro Flo) Many Other Parts with Sealer Underhead Available from Stock)

* This part can also be used as a grain bin bolt.
Note: Additional Parts Available. See Price Sheet
on Mating Screws & Molded Fasteners
P. O. A. = Priced on Application

\$25.00 Line Minimum \$50.00 Order Minimum
Torx® is a Trademark of Camcar Div of Textron
Corro Flo may be a trade mark of Camcar Div. of Textron
†No Lock Patch

Engineered Components

visit our web site for a video tour
www.engcomponents.com

M6 TORX®/6-LOBE T-NUTS & BOLTS

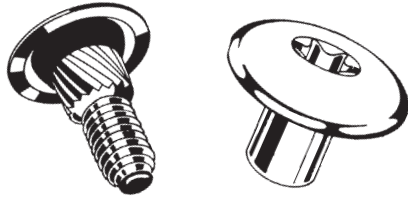

BOLTS MOLDED (ENCAPSULATED) OR NON-MOLDED

PART #	500	1,000	2,500	5,000	10,000	25,000	50,000
M6-1.0x8.00 Torx® or 6-Lobe T-50 Drive GR-5.1 T-Nut .0003 Zinc							
F0817205-06							
M6-1.0x9.52 Torx® or 6-Lobe T-50 Drive GR-5.1 T-Nut .0003 Zinc							
F0817245-06							
M6-1.0x12.7 Torx® or 6-Lobe T-50 Drive GR-5.1 T-Nut .0003 Zinc							
F0817345-06							
M6-1.0x15.49 Rib Undercut GR-5.1 HDRPT .0003 CAD & JD Lock Patch & Seal UH							
F6717419-963092							
M6-1.0x18.67 Rib Undercut GR-5.1 HDRPT .0003 CAD & JD Lock PA & Seal UH							
F6717499-963092							

Call For Pricing on Molded Encapsulated Grey or White
 Also Available Without Seal at Lower Cost
 JD DIP on .0003 Cad has 1500 Hours of Salt Spray
 \$25.00 Line Minimum \$50.00 Order Minimum
 Torx® is a Trademark of Camcar Div. Of Textron

PART #	500	1,000	2,500	5,000	10,000	25,000	50,000
3/8-16x1 Torx® or 6-Lobe Btn Hd Undercut .0003 Min CAD & JD and Sealer Under Head							
F8721665-9892							
3/8-16x1-7/8 Torx® or 6-Lobe Btn Hd Undercut .0003 Min CAD & JD and Sealer Under Head							
F8721735-9892							

F8721665-9892 and F8721735-9892 are alternates to
 Coro Flo and are not Mfg. by Camcar
 F8721735-9892 may be 10,000 pcs min. order

The above parts may or may not be manufactured by Camcar
 Torx® is a Registered Trademark of Camcar Textron
 Coro Flo® is a Registered Trademark of camcar Textron

Engineered Components

847-841-7000 • Fax 847-841-7007

REAR DOOR HARDWARE F.R.P. ASSEMBLY AND REPAIR

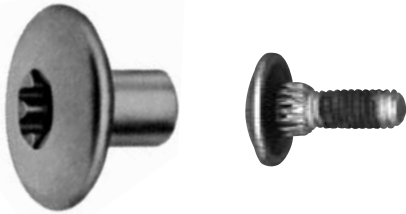

Call For Pricing For Encapsulated Head

PART #	500	1,000	2,500	5,000	10,000	25,000	50,000
5/16-18x3/8 Torx® or 6-Lobe T-55 Drive GR-5.1 T-Nut Zinc							
F0819245-06							
5/16-18x1/2 Torx® or 6-Lobe T-55 Drive GR-5.1 T-Nut Zinc							
F0819345-06							
5/16-18x5/8 Torx® or 6-Lobe T-55 Drive GR-5.1 T-Nut Zinc							
F0819425-06							
5/16-18x3/4 Rib Undercut GR-5.1 HDR PT .0003 CA and JD Lock Patch & Seal							
F6719500-963092							
5/16-18x7/8 Rib Undercut GR-5.1 HDR PT .0003 CA and JD Lock Patch & Seal							
F6719580-963092							
5/16-18x1 Rib Undercut GR-5.1 HDR PT .0003 CA and JD Lock Patch & Seal							
F6719660-963092							
5/16-18x1-1/4 Rib Undercut GR-5.1 HDR PT .0003 CA and JD Lock Patch & Seal							
F6719680-963092							
5/16-18x1-1/2 Rib Undercut GR-5.1 HDR PT .0003 CA and JD Lock Patch & Seal							
F6719700-963092							



STEP BOLT GRADE 5

Also Available Without Seal at Lower Cost
JD DIP on .0003 Cad has 1500 Hours of Salt Spray
P. O. A. = Priced on Application
Torx® is a Trademark of Camcar Div. of Textron

PART #	500	1,000	2,500	5,000	10,000	25,000	50,000
3/8-16 x 1-1/2 Gr5 Step Bolt 0005 Zinc + J.D. Dip (500Hr. Salt Spray)							
F1521709-06							
3/8-16 x 1-1/4 Gr-5 Step Bolt Zinc							

Other Grade 5 Step Bolts Available Upon Request

DOOR HOLD BACK HARDWARE Hot Dip Galvanized



SIZES AVAILABLE	PART #	25	50	100	250	500	1,000
1/4" dia. 3 Loop Chain Galv.	F9913998-13						
1/4" dia. 2 Loop Chain Galv.	F9913997-13						
1/4" dia. Split Lap Link Galv.	F9917999-13						
5/16" dia. Hook PP Galv.	F9913999-13						

All Parts Hot Dip Galv.

Engineered Components

visit our web site for a video tour
www.engcomponents.com

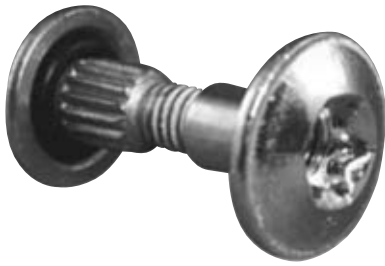

ABM PANELOK™

Anchor Bolt & Screw Co. has taken the worry out of FRP and door hardware fasteners with the uniquely designed, built-to-last ABM Panelok™ System.

Our years of experience have allowed us to engineer this part for extra strength and durability. The ABM Panelok™ has been proven to outlast all other door and FRP hardware currently available in the market.

Often imitated, never duplicated.

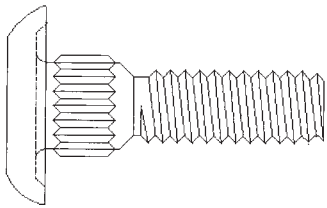

ABM Panelok™ Bolts – This modified FRP bolt has been designed to provide a low profile, large diameter head and radius fillet for an even pressure clamp load. It has been designed with an undercut radius. The locking feature on this part provides a chemical bond with the accompanying T-Nut. The ribbed neck provides a lock into the hinge or FRP panel to prevent unwanted twisting.

	7/8	1	1-1/4
5/16-18			

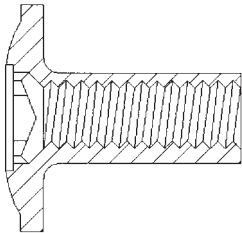

ABM Panelok™ T-Nut – This special T-Nut has been designed with a low profile head and a T-55 Torx® (or equivalent 6 lobe) drive to make this a tamper resistant fastening system.

	3/8	1/2	5/8
5/16-18			

Numbers in tables are Base Items
 Please refer to page 00

Engineered Components

847-841-7000 • Fax 847-841-7007

CAMTAINER® FASTENING SYSTEM

Nut & bolt systems for truck trailer assemblies



Steel, High Corrosion Resistant Plated Camtainer® Bolts	ECC Part #	500	1,000	2,500	5,000	10,000	25,000
M6 x 1.0 x 12.32mm	F9571-05206						
M6 x 1.0 x 15.49mm	F9572-01406						
M6 x 1.0 x 18.67mm	F9573-00506						
M6 x 1.0 x 21.84mm	F9574-00606						
M6 x 1.0 x 25.02mm	F9575-02706						
5/16-18 x 5/8	F9576-06408						
5/16-18 x 3/4	F9577-00508						
5/16-18 x 7/8	F9578-21128						
5/16-18 x 1	F9579-02928						
5/16-18 x 1 1/4	F9580-00038						
5/16-18 x 1 7/16	F9581-09058						
Steel, High Corrosion Resistant Plated Camtainer® II Encapsulated (Molded) Bolts							
M6 x 1.0 x 12.32mm	F9582-C5206						
M6 x 1.0 x 15.49mm	F9583-C1406						
M6 x 1.0 x 18.67mm	F9584-C0506						
M6 x 1.0 x 21.84mm	F9585-C0606						
M6 x 1.0 x 25.02mm	F9586-C6408						
5/16-18 x 5/8	F9587-C0508						
5/16-18 x 3/4	F9588-C1128						
5/16-18 x 7/8	F9589-C2928						
5/16-18 x 1	F9590-C0038						
5/16-18 x 1 7/16	F9591-C9508						
Steel, High Corrosion Resistant Plated Torx® Drive Flanged Nuts							
M6 x 8.00mm	F9592-00074						
M6 x 9.52mm	F9593-00084						
M6 x 12.70mm	F9594-00005						
5/16 x 1.000	F9598-55006						

Torx® is a Registered Trademark of Camcar Textron
 Camtainer® is a registered trademark of Camcar Textron

NEW ERA IN RUST PROTECTION

"**The next best thing to stainless steel**" an upgrade to your plated steel parts. We currently supply various fasteners and other components that will reach **4,000 hour salt spray** for a clear silver finish and close to **4,200 hours** for a yellow dichromate finish.

ECC has concluded our testing, and are now offering our new coating that will achieve **10,000 PLUS hours**.

Engineered Components Company has been an **INNOVATOR** in achieving the highest salt spray results in our industry.

Our economy has been faced with runaway prices for stainless steel components. All forecasting for future costs have been thrown out the window. We believe prices will continue to fluctuate for the unforeseeable future.

Greater demands are being put on the corrosion resistance of plated steel components. Higher salt spray results are required by original equipment manufacturers across the country.

ECC WOULD BE PLEASED TO COAT AND TEST SAMPLES OF ITEMS YOU WISH TO CONVERT

**THE NEXT BEST THING TO
STAINLESS STEEL
4,000 HOURS & 10,000 PLUS HOURS SALT SPRAY**

BOTTOM RAIL BOLTS & NUTS

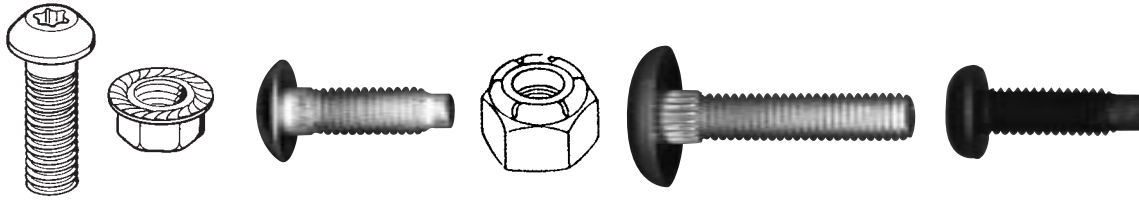

SIZES AVAILABLE	PART #								
		500	1,000	2,500	5,000	10,000	25,000	50,000s	
Torx® or 6-Lobe Steel GR-5.1 .0003 Minimum Cad with JD #5+ (to withstand 4000 hours)									
3/8-16x1 Button Shoulder GR-5.1	F8721668-96								
3/8-16x1-1/4 Button Shoulder GR-5.1	F8721689-96								
3/8-16x1-1/4 Truss w/Dog Shoulder Point GR-5.1	F8721687-98								
3/8-16x1-1/2 Truss Shoulder GR-5.1	F8721705-96								
3/8-16x1-7/8 Truss Shoulder GR-5.1	F8721735-96								
Torx® or 6-Lobe 18-8 (302) Stainless Steel Double Bright									
3/8-16x1 Button Head Shoulder Stainless	F8721668-19								
3/8-16x1-1/4 Button Head Shoulder Stainless	F8721689-19								
3/8-16x1 Truss Head Shoulder Stainless	F8721665-19								
3/8-16x1-1/2 Truss Head Shoulder Stainless	F8721705-19								
3/8-16x1-1/2 Button Head Shoulder Stainless	F8721709-19								
3/8-16 Nuts									
3/8-16 Nylon Insert LN Zinc	F0421000-06								
3/8-16 Serrated LN Case Hard Zinc	F0721000-06								
Encapsulated Bottom Rail Bolts									
3/8-16x1 Rib Neck CB GR-5.1 Grey	F6721668-0607								
3/8-16x1 Rib Neck CB GR-5.1 White	F6721668-0601								
3/8-16x1-7/8 Grey Rib Neck CB GR-5.1 Low Profile	F6721738-0607								
Self Tapping Bottom Rail Bolts (Torx® or 6-Lobe with Dog Point Thread Forming Plain Finish)									
3/8-16x1-1/4 Button	F8721689-0299								
Torx® or 6-Lobe Grade 5.1 Commercial Zinc Fine Thread									
3/8-24x1-1/4 Button	F8722689-06								

Engineered Components

visit our web site for a video tour
www.engcomponents.com

ADDITIONAL BOTTOM RAIL BOLTS AND MISCELLANEOUS ITEMS



3/8-16x1 BUTTON TAMPERPROOF TORX® OR 6 LOBE TRI-LOBE HARD ZINC

Tamper Resistant Rear Door Fastener

500	1,000	2,500	5,000	10,000	25,000	50,000	100,000

3/8-16x1-1/8 TORX® OR 6-LOBE TRUSS HD MS 18-8 SS

Truck Body Bottom Rail Bolt

500	1,000	2,500	5,000	10,000	25,000

3/8-16x2-1/4 TORX® OR 6-LOBE TRUSS HD MS 18-8 SS

Truck Body Bottom Rail Bolt

500	1,000	2,500	5,000	10,000	25,000

1/4 I.D. x 1-3/16 O.D. COUNTERSUNK FLAT WASHER

For 1/4" Flat Head Screws for Large Bearing Surface

500	1,000	2,500	5,000	10,000	25,000



Zinc Green Plated

10-32x3/8 SLOTTED IND HEX WASHER UC TYPE F TCS HARD ZINC & GREEN

Ground Screws

500	1,000	2,500	5,000	10,000	25,000	50,000	100,000	250,000

BOTTOM RAIL BOLTS



A Bottom Rail Bolt, also known as the cross member bolt, is a structural bolt used in the assembly of truck trailers. These bolts are used to fasten and hold the bottom rail and the side wall to the cross member. These bolts are designed to be strong, fasten tight, and remain tight.

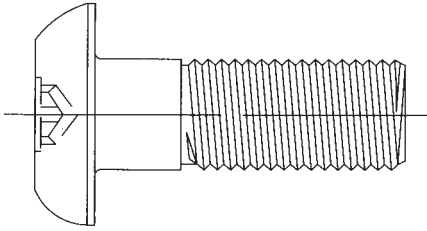

Bottom Rail Bolts

Size	1/4	5/16	1/2	15/16	1	1-1/4	1-1/2	1-3/4	2	2-1/4	2-1/2	2-3/4	3
4													
5													
6													
8													
10													
12													
14													
1/4													
5/16													
3/8													
1/2													

** Denotes item available request

visit our web site for a video tour
www.engcomponents.com

REPAIR KITS

Bottom Rail
 Landing Gear
 Rear Door

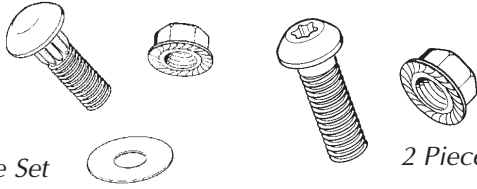

3 Piece Set

2 Piece Set

ALL PRICES PER BAG

SIZES AVAILABLE	PART #					
		60	120	240	480	960
3 Piece Bottom Rail Kit (24 pieces per bag 8 Bolts, 8 Nuts, 8 Washers)						
3/8-16x1-1/4 Gr 5.1 Rib Neck Steel Carr Bolt Zinc with 3/8-16 Hex Flange Serr Steel Nut Zinc 3/8 Nylon Flat Washer	F9921689-99					

SIZES AVAILABLE	PART #					
		75	150	300	600	1,200
2 Piece Bottom Rail Kit (16 pieces per bag 8 Bolts, 8 Nuts)						
3/8-16x1-1/4 Torx® Equiv. Button Head Steel Gr. 5.1 Bolt .0003-.0005 Cad & Non-Galvanic Dip 3/8-16 Hex Flange Serr Steel Nut Zinc	F9921688-99					

LARGE QUANTITY BOTTOM RAIL BOLTS GRADE 5 & 18-8 (300 SERIES) STAINLESS STEEL AVAILABLE, SEE BULK PRICE LIST

\$25.00 Line Minimum \$50.00 Order Minimum

TORX® is a Trademark of Camcar Div. of Textron

LANDING GEAR

36 parts per bag (12 bolts 12 lock nuts 12 washers)

SIZES AVAILABLE	PART #					
		25	50	100	200	300
5/8-18 x 1-7/8 Grade 8 Bolts Zinc Yellow with Zinc Lock Nuts and Flat Washers	F9930749-99					
5/8-11 x 1-3/4 Grade 5 Bolts Black with Zinc Lock Nuts						
Rear Door (100 Per Box)						
1/4-20 x 1-1/2 Elevator Bolts Zinc 1/4-20 Keps Nuts Zinc 100 per Box	F9917709-99					

STEP BOLTS FOR SWING DOOR REPAIR SEE PAGE 12
 OTHER KITS AVAILABLE UPON REQUEST

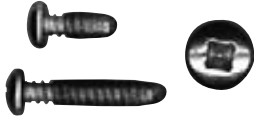

SIZES AVAILABLE	PART #								
		500	1,000	2,500	5,000	10,000	25,000	50,000	100,000
Phillips Pan Head 410 Stainless Steel TCS Bright Hard and Passivated									
10/24x1	F2913664-19								
#10 Square Drive Phillips Pan Head 410 SS Type B SMS Nickel Strike Cad with Biwax									
1/2"	F2313349-1902								
3/4"	F2313509-1902								
1"	F2313669-1902								
#10 Phillips Pan Head Steel Self Drilling Screw Zinc									
1/2"	F3513344-06								
5/8"	F3513424-06								
3/4"	F3513504-06								
1"	F3513664-06								
1-1/4"	F3513684-06								
1-1/2"	F3513704-06								

P. O. A. = Priced on Application
 \$25.00 Line Minimum \$50.00 Order Minimum

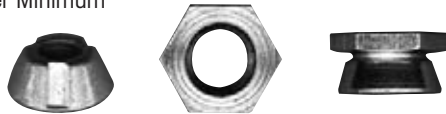

TAMPER RESISTANT NUTS

SIZES AVAILABLE	PART #	500	1,000	2,500	5,000	10,000	25,000
3/8-16 Tamper Resistant Zinc Dycast with 360° Nylon Lock Patch	F0821000-94						

SIZES AVAILABLE	PART #	1 Piece	5 Pieces	10 Pieces	25 Pieces & Up
Tamper Resistant Socket for 3/8-16 Tamper Resistant Nut	#30				

SIZES AVAILABLE	PART #	500	1,000	2,500	5,000	10,000	25,000
3/8-16 Special Hex Drive Tamper Resistant .0003 Zinc with 360° Nylon Lock Patch	F0821999-35						
1/2-13 Special Hex Drive Tamper Resistant .0003 Zinc*	F0825999-35						

Special Hex Drive Tamper Resistant Available in Sizes from 4/40 to 4" Diameter *Available with 360° Patch – Call for Pricing
 \$25.00 Line Minimum \$50.00 Order Minimum

visit our web site for a video tour
www.engcomponents.com

ALUMINUM DRIVE RIVETS SOUTHCO ALTERNATES

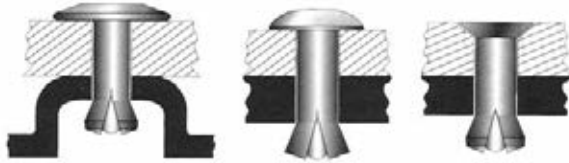

ECC Part #	SOUTH CO PART #	500	1M	2500	5M	10M	25M	50M	100M
DRV406013	38-106-04-16	65.52	59.57	54.15	49.23	46.88	44.65	42.53	40.50
DRV606013	38-106-06-16	75.23	68.39	62.17	56.52	53.83	51.27	48.83	46.50
DRV806013	38-106-08-16	76.44	69.49	63.18	57.43	54.70	52.09	49.61	47.25
DRV016013	38-106-10-16	80.24	72.95	66.32	60.29	57.42	54.68	52.08	49.60
DRV408013	38-108-04-16	93.43	84.94	77.22	70.20	66.85	63.67	60.64	57.75
DRV306023	38-206-03-16	76.44	69.49	63.18	57.43	54.70	52.09	49.61	47.25
DRV406023	38-206-04-16	76.44	69.49	63.18	57.43	54.70	52.09	49.61	47.25
DRV606023	38-206-06-16	77.66	70.60	64.18	58.34	55.57	52.92	50.40	48.00
DRV806023	38-206-08-16	77.66	70.60	64.18	58.34	55.57	52.92	50.40	48.00
DRV016023	38-206-10-16	77.66	70.60	64.18	58.34	55.57	52.92	50.40	48.00
DRV416023	38-206-14-16	92.22	83.83	76.21	69.28	65.98	62.84	59.85	57.00
DRV618023	38-208-06-16	77.66	70.60	64.18	58.34	55.57	52.92	50.40	48.00
DRV808023	38-208-08-16	95.94	87.22	79.29	72.08	68.65	65.38	62.27	59.30
DRV406033	10-99-106-11	75.23	68.39	62.17	56.52	53.83	51.27	48.83	46.50
DRV706033	10-99-106-12	94.64	86.04	78.22	71.11	67.72	64.50	61.43	58.50
DRV406073	10-11-706-13	75.23	68.39	62.17	56.52	53.83	51.27	48.83	46.50
DRV706073	10-12-706-13	76.44	69.49	63.18	57.43	54.70	52.09	49.61	47.25
DRV216073	10-99-122-13	87.36	79.42	72.20	65.64	62.51	59.54	56.70	54.00
DRV016073	10-13-706-13	77.66	70.60	64.18	58.34	55.57	52.92	50.40	48.00
DRV316073	10-14-706-13	89.79	81.63	74.21	67.46	64.25	61.19	58.28	55.50
DRV716073	10-15-706-13	93.51	85.01	77.28	70.26	66.91	63.72	60.69	57.80
DRV026073	10-16-706-13	93.51	85.01	77.28	70.26	66.91	63.72	60.69	57.80
DRV626073	10-18-706-13	126.19	114.72	104.29	94.81	90.29	86.00	81.90	78.00
DRV808013	38-108-08-16								

Engineered Components

847-841-7000 • Fax 847-841-7007

TRUCK BUMPERS

Made from Virgin Rubber
Not Recycled Materials

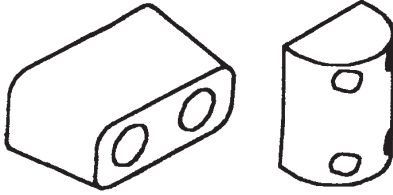

SIZES AVAILABLE	PART #	21	63	105	210	420
8X5 Standard 4 Hole	F9999920-R03					
6x2-3/8 Standard 2 Hole	F9999770-R03					

1/2-20x2 TORX® or 6-LOBE PAN "F" TCS CAD SELF TAPPING BUMPER BOLT

PART #	500	1,000	2,500	5,000	10,000
F9026744-02					

Thread cutting screw for mounting bumpers in blind or open applications

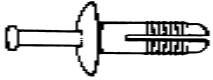

NYLON DRIVE RIVET WITH ALUMINUM OR STEEL PIN

SIZES AVAILABLE	PART #	1,000	2,500	5,000	10,000	25,000	50,000	100,000
3/16 x 3/4 with Steel Pin	4460116							
1/4 x 3/4* with Alum. Pin	6110645							

These two parts are made from DuPont Zytel 101

Other sizes available

* 1/4 x 3/4 equal to SOUTHCO #30-20-542-25

TORX® or 6-Lobe Flat Head Steel Machine Screw Grade 5.1— Plain

SIZES AVAILABLE	PART #	500	1,000	2,500	10,000	25,000	50,000
3/8-16x5	F8721927-96						

The above part can be cut to length and threaded to whatever length you require.

STEEL WHEELS

ECC Part#	Outer Thread	Inner Thread	Length	Type	100	250	500	1,000	2,500	5,000
EC1-80701-07	1-1/8-16	3/4-16	2-7/32	Right Hand						
EC2-90701-07	1-1/8-16	3/4-16	2-7/32	Left Hand						

STEEL WHEELS EXTRA LENGTH

ECC Part#	Outer Thread	Inner Thread	Length	Type	100	250	500	1,000	2,500	5,000
EC3-63353-07	1-1/8-16	3/4-16	2-9/16	Right Hand						
EC4-73353-07	1-1/8-16	3/4-16	2-9/16	Left Hand						

STANDARD OUTER NUTS

Zinc & Yellow
 For Steel or Aluminum Wheels



ECC Part#	Thread	Hex A.F.	Height	Type	100	250	500	1,000	2,500	5,000
EC5-19873-07	1-1/8-16	1-1/2	7/8"	Right Hand						
EC6-29873-07	1-1/8-16	1-1/2	7/8"	Left Hand						

Inner caps Also Available for Aluminum Wheels



M22 WHEEL BOLT AND NUT for piloted hub tractors and trailers

	PART #	100	250	500	1,000	2,500	5,000
M22 Nut	F0899000-0182						
M22 Bolt	F1834999-01						

WHEEL NUTS (60°) Grade 2 Zinc



SIZE	ECC PART #	500	1,000	2,500	5,000	10,000	15,000	25,000	50,000
7/16-20	EC437-20-2-06								
1/2-20	EC500-20-2-06								
5/8-18	EC625-18-2-06								

Engineered Components

847-841-7000 • Fax 847-841-7007

TRAILER HUB HEAT SENSOR BOLTS

4037 Steel Heat Treated

Part Number	Quantity	Description
F1819581-0892-4	4 Per Bag	Replaces existing hub cap bolts
F1819581-0892-100	100 Per Bag	*Installs in seconds with simple hand tool
F1819581-0892	1000 Per Bag	*Provides early warning of bearing problems, preventing costly repairs, and trailer downtime. *Provides a visual indicator that lets you know at a glance if a hub reaches 250° Your low cost insurance policy for possible hub lose or damage

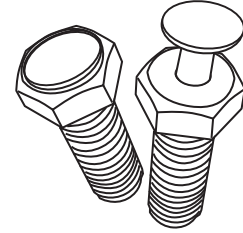

Heat Sensor Pop-Up Bolts pops up at 250°

SERRATED HEX WASHER FLANGE SCREWS

Grade 2 Zinc Plated



Size	500	1,000	2,500	5,000	10,000	25,000
1/4-20 x 1/2						
1/4-20 x 1-1/4						
1/4-20 x 1-1/2						
5/16-18 x 1/2						
5/16-18 x 3/4						
5/16-18 x 7/8						
5/16-18 x 1						
5/16-18 x 1-1/2						
5/16-18 x 1-3/4						
3/8-16 x 1/2						
3/8-16 x 3/4						
3/8-16 x 1						
3/8-16 x 1-1/2						
1/2-13 x 1-1/4						
1/2-13 x 1-1/2						

Engineered Components

visit our web site for a video tour
www.engcomponents.com

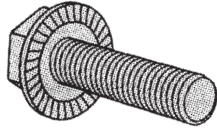

SERRATED HEX WASHER FLANGE SCREWS

Grade 5 Case Hard Zinc Plated
 Wiz Lock Alternate

SIZES AVAILABLE	PART #	500	1,000	2,500	5,000	10,000	25,000
1/4-20x1/2	F2517343-06						
1/4-20x5/8	F2517423-06						
1/4-20x3/4	F2517659-06						
1/4-20x1	F2517663-06						
1/4-20x1-1/4	F2517683-06						
1/4-20x1-1/2	F2517703-06						
1/4-20x2	F2517743-06						
1/4-20x2-1/2	F2517783-06						
5/16-18x1/2	F2519343-06						
5/16-18x5/8	F2519423-06						
5/16-18x3/4	F2519503-06						
5/16-18x1	F2519663-06						
5/16-18x1-1/4	F2519683-06						
5/16-18x1-1/2	F2519703-06						
5/16-18x2	F2519743-06						
3/8-16x1/2	F2521343-06						
3/8-16x3/4	F2521503-06						
3/8-16x1	F2521663-06						
3/8-16x1-1/4	F2521689-06						
3/8-16x1-1/2	F2521703-06						
3/8-16x2	F2521749-06						
3/8-16x2-1/2	F2521783-06						
3/8-16x3	F2521813-06						
1/2-13x3/4	F2525503-06						
1/2-13x1	F2525663-06						
1/2-13x1-1/4	F2525683-06						
1/2-13x1-1/2	F2525703-06						
1/2-13x1-3/4	F2525723-06						
1/2-13x2	F2525743-06						
1/2-13x2-1/2	F2525783-06						
1/2-13x3	F2525813-06						

Wiz Lock May Be a Registered Trademark of McLean Fogg

SERRATED HEX FLANGE NUTS

Case Hard Zinc

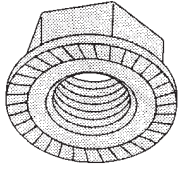

SIZES AVAILABLE	ECC PART #	500	1,000	2,500	5,000	10,000	25,000
6/32							
8/32	F0712009-06						
10/24	F07130SE-06						
10/32	F0714000-06						
1/4-20	F0717000-06						
5/16-18	F0719009-06						
3/8-16	F0721000-06						
7/16-14							
1/2-13	F0725009-06						

Engineered Components

visit our web site for a video tour
www.enacomponents.com

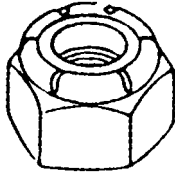

I.F.I GRADE 5 NYLON INSERT LOCK NUTS .0005 ZINC & CLEAR

Can be converted to yellow and special
after dips to increase salt spray hours

Size	ECC Part #	1,000	2,500	5,000	10,000	25,000	50,000	100,000
1/4-20	F0417000-90							
5/16-18	F0419000-60							
3/8-16	F0421000-90							
3/8-24	F0422000-90							
1/2-13	F0425000-90							
1/2-20	F0426000-90							
5/8-18	F043000-90							
3/4-16	F0432000-90							

****** ABOVE ARE ACTUAL ******
GRADE 5 LOCK NUTS WITH GRADE 5 MARKINGS.
THEY ARE NOT GRADE 2 TESTED
AND CERTIFIED TO GRADE 5.

GRADE 2 ALSO AVAILABLE

GRADE 5 AND GRADE 8 2-WAY LOCK NUTS ZINC

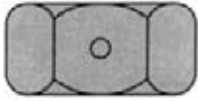

Grade 5

Size	1,000	2,500	5,000	10,000	25,000	50,000
1/4-20						
1/4-28						
5/16-18						
5/16-24						
3/8-16						
3/8-24						
7/16-14						
7/16-20						
1/2-13						
1/2-20						

Grade 8

Size	1,000	2,500	5,000	10,000	25,000	50,000
1/4-20						
1/4-28						
5/16-18						
5/16-24						
3/8-16						
3/8-24						
7/16-14						
7/16-20						
1/2-13						
1/2-20						

Engineered Components

visit our web site for a video tour
www.engcomponents.com

FLANGE NUTS NO SERRATIONS

Plain & Not Hardened

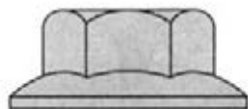

Size	1,000	2,500	5,000	10,000	25,000	50,000
1/4-20						
5/16-18						
3/8-16						
1/2-13						



TWIN WIZ SERRATED LOCK NUTS

Machine Screw and Finished Nuts Serrated Both Sides

Size	1,000	2,500	5,000	10,000	25,000	50,000
4/40 x 1/4 x 3/32						
6/32 x 5/16 x 7/64						
8/32 x 11/32 x 1/8						
10/24 x 3/8 x 3/16						
10/24 x 3/8 x 1/8						
10/32 x 3/8 x 3/16						
10/32 x 3/8 x 1/8						
1/4-20 x 7/16 x 7/32						
5/16-18 x 1/2 x 17/64						
3/8-16 x 9/16 x 21/64						

2 WAY LOCK NUT DEFLECTION Service Only

SIZES AVAILABLE	PART #	GRADE		
		2	5	8
Steel				
1/4-20				
1/4-28				
5/16-18				
5/16-24				
3/8-16				
3/16-24				
1/2-13				
1/2-20				
Brass, Silicon Bronze, Stainless Steel, Monel				
		Under 100,000 Pcs	Over 100,000 Pcs	
1/4-20				
1/4-28				
5/16-18				
5/16-24				
3/8-16				
3/8-24				
1/2-13				
1/2-20				

\$350.00 Order Minimum
We Can Centerlock Per Your Spec.(Ft. Lbs.)

**SEND US
YOUR PRODUCT FOR 2-WAY
DEFLECTION**

Engineered Components

visit our web site for a video tour
www.engcomponents.com

TRAILER BRAKE HOSE SPRINGS

Other Sizes and Finishes Available,
 Call for Details



Spring

DESCRIPTION	O/A	O.D. LGTH	WIRE	FINISH	PART #	CTN QTY	1/4 CTN	1/2 CTN	1 CTN	3 CTN
2-1/2" x 3/4" Spring	2.5"	.075	0.0625	Zinc/Yellow Dichromate*	100-610-90	500				
11" x 3/4" Spring	11.1"	.075	0.0625	Zinc/Yellow Dichromate*	111-910-90	40				
13" x 3/4" Spring	13.6"	.075	0.0625	Zinc/Yellow Dichromate*	020-110-90	100				
9" x 11/16" Spring	9.0"	1.06	0.080	Zinc/Yellow Dichromate*	120-910-90	35				
13-1/2" x 11/16" Spring	13.5"	1.06	0.080	Zinc/Yellow Dichromate*	820-910-90	30				
16-1/2" x 11/16" Spring	16.5"	1.06	0.080	Zinc/Yellow Dichromate*	100-310-90	25				
25" x 11/16" Spring	25.0"	1.06	0.080	Zinc/Yellow Dichromate*	510-800-90	10				

Our Springs Feature:

- Class 1 Hard Drawn Spring Wire
- Double Lift Up Loop at Both Ends
- Finishes with * Meet 96 Hour Salt Spray Resistance

EYE BOLT W/KEPS & LOCK NUT



DESCRIPTION	PART #	CTN QTY	1/4 CTN	1/2 CTN	1 CTN	3 CTN
Eye Bolt W/Keps & Lock Nut	520-110-90	750				

SPRING PLATE

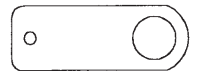

DESCRIPTION	PART #	CTN QTY	1/4 CTN	1/2 CTN	1 CTN	3 CTN
Spring Plate	200-810-90	2,000				

HOSE SEPARATOR OPTIONS

- Any Heavy Duty Hose Separator W/Eye Bolt
- Or Any Heavy Duty 3 Hole Separator W/V-Bolt

Note: See next page for hose separators

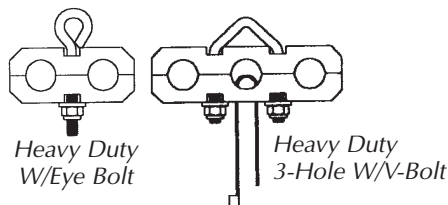

BRAKE HOSE SEPARATORS

Sizes are Brake Hose I.D.

HEAVY DUTY W/EYE BOLT

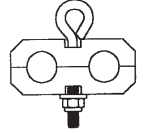

PART #	CTN QTY	SIZE	1/4 CTN	1/2 CTN	1 CTN	3 CTN
A110-990-10	500	3/8" H.D. W/ E. B.				
A310-990-10	500	1/2" H.D. W/ E. B.				

HEAVY DUTY 3 HOLE W/V-BOLT

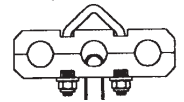

PART #	CTN QTY	SIZE	1/4 CTN	1/2 CTN	1 CTN	3 CTN
A910-810-90	300	3/8" No Tie				
A710-020-90	300	3/8" With Tie				

STANDARD



PART #	CTN QTY	SIZE	1/4 CTN	1/2 CTN	1 CTN	3 CTN
100-990-10	2m	3/8"				
010-990-10	2m	1/2"				

HEAVY DUTY IN-LINE

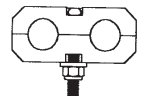

PART #	CTN QTY	SIZE	1/4 CTN	1/2 CTN	1 CTN	3 CTN
A410-990-10	500	3/8" Two Hole				
A510-990-10	500	1/2" Two Hole				

HEAVY DUTY 3 HOLE IN-LINE

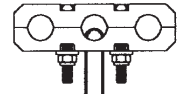

PART #	CTN QTY	SIZE	1/4 CTN	1/2 CTN	1 CTN	3 CTN
A220-710-90	250	3/8" No Tie				
A260-710-90	250	3/8" With Tie				

Engineered Components

visit our web site for a video tour
www.engcomponents.com

STANDARD BEAM CLIP ASSEMBLIES

Sizes are Flange Thickness –
 Available with Many
 Different Cable Ties

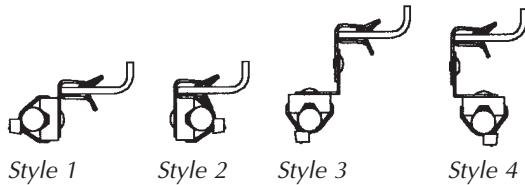

DESCRIPTION	FINISH	CABLE TIE	PART #	CARTON QTY	1/4 CTN	1/2 CTN	1 CTN	3 CTN
1/8"-1/4" Beam Clip Assembly with 7-1/2" Cable Tie (Style 1)	Zinc/Yellow Dichromate*	7-1/2"	A110-610-90	1,000				
1/8"-1/4" Beam Clip Assembly with 7-1/2" Cable Tie (Style 2)	Zinc/Yellow Dichromate*	7-1/2"	A900-510-90	1,000				
1/8"-1/4" Beam Clip Assembly with HD 14" Cable Tie (Style 1)	Zinc/Yellow Dichromate*	14" HD	A020-710-90	1,000				
1/8"-1/4" Beam Clip Assembly with HD 14" Cable Tie (Style 2)	Zinc/Yellow Dichromate*	14" HD	A120-710-90	1,000				
5/16"-1/2" Beam Clip Assembly with HD 8" Cable Tie (Style 1)	Zinc/Yellow Dichromate*	8" HD	A610-020-90	500				
9/16"-3/4" Beam Clip Assembly with HD 8" Cable Tie (Style 1)	Zinc/Yellow Dichromate*	8" HD	A110-020-90	500				
1/8"-1/4" Beam Clip Assembly with HD 14" Cable Tie (Style 3)	Zinc/Yellow Dichromate*	14" HD	A420-020-90	500				
1/8"-1/4" Beam Clip Assembly with HD 14" Cable Tie (Style 4)	Zinc/Yellow Dichromate*	14" HD	A220-020-90	500				

Beam Clip Advantages:

- Easy to Install
- No Grommet Needed
- No Sharp Edges
- No Welding Needed
- Great for Wire, Air Hoses, Air Tubes, Etc.
- Finishes with * are .0005" Zinc (approx. 325 HR S.S.R.)

HOSE CLIP WITH CABLE TIE MOUNT ASSEMBLY

Sizes are Hose I.D.

**ABS CLIPS
 AVAILABLE UPON
 REQUEST**



DESCRIPTION	CABLE TIE	PART #	CARTON QTY	1/4 CTN	1/2 CTN	1 CTN	3 CTN
3/8"-1/2" Hose Clip with 7-1/2" Cable Tie Assembly	7-1/2"	A310-001-10	1,000				
3/8"-1/2" Hose Clip with any size Cable Tie		Call for No.					

Hose Clip Advantages:

- Not Tied Directly to Hose
- Clean Wire Management
- Can be Used to Secure Hose to Susp. Cross Tube or Axle
- Will Not Chafe Hose
- Great for Wire, Grease Lines, or Tying Up Extra Power or Sensor Wire
- Removable — Can Be Reattached



ECONOMY BLACK UV STABILIZED WIRE TIES

TENSILE STRENGTH	LENGTH	BAG QUANTITY	PART #	1,000	5,000	10,000	25,000	50,000	100,000
18#	4"	Bulk	814TCB						
18#	6"	Bulk	816TCB						
40#	8"	Bulk	048TCB						
40#	11"	Bulk	0411TCB						
50#	14"	Bulk	0551TCB						

ECONOMY NATURAL WIRE TIES

TENSILE STRENGTH	LENGTH	BAG QUANTITY	PART #	1,000	5,000	10,000	25,000	50,000	100,000
18#	4"	Bulk	814TCN						
18#	6"	Bulk	816TCN						
40#	8"	Bulk	048TCN						
40#	11"	Bulk	0411TCN						
50#	14"	Bulk	0551TCN						

Above Economy Wire Ties are Bulk Not Bagged
 Other Sizes Available of Economy Wire Ties with Larger Quantities Required. [PLEASE INQUIRE](#)

UV STABILIZED BLACK WIRE TIES

TENSILE STRENGTH	LENGTH	BAG QUANTITY	PART #	1 BAG	2 BAGS	10 BAGS	25 Bags	50 Bags	100 BAGS
40#	5-1/2"	1,000	035-10-20-6B						
50#	8"	1,000	057-20-20-7.5B						
40#	8-1/2"	1,000	048-70-20-8B						
50#	11.8"	1,000	0511-20-20-11B						
120#	15"	100	02141-30-20-14B						
120#	18"	50	02181-30-20-18B						
120#	21"	50	02142-30-20-24B						
175#	36"	50	57163-40-20-36B						

Natural Material and Other Sizes Available Upon Request
 M = Per Thousand
 B = Per Bag

Engineered Components

visit our web site for a video tour
www.engcomponents.com

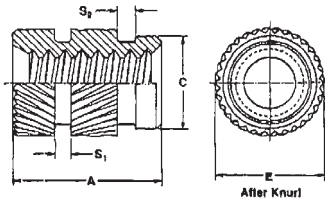

ULTRASONIC-SONIC LOCK BRASS INSERTS

Straight Wall, Thru-Threaded
 Designed for use in straight holes

Size	ECC Part #	500	1,000	5,000	10,000	25,000	50,000	100,000
2-56								
4-40								
6-32								
8-32								
10-24								
10-32								
1/4-20	F9918340-70							
1/4-28								
5/16-24								
3/8-16								

Thread Code (1)	A ± .005	E ± .005	C Body Dia. ± .005	S1	S2	Hole Size in Material	
						Min. Hole Depth	Hole Dia. + .003 - .000
2-56	.157	.137	.121	.031	.031	.187	.127
4-40	.226	.179	.152	.031	.031	.256	.158
6-32	.281	.210	.188	.031	.031	.311	.189
10-24	.321	.243	.217	.031	.040	.351	.229
10-32	.375	.273	.247	.046	.046	.405	.253
1/4-20	.500	.342	.310	.046	.062	.530	.316
1/4-28	.500	.342	.310	.046	.062	.530	.316
5/16-24	.500	.500	.400	.372	.046	.062	.530
3/8-16	.500	.500	.400	.372	.046	.062	.530

Engineered Components

847-841-7000 • Fax 847-841-7007



AVK ALTERNATES RIVET NUTS SERRATED AND NON-SERRATED INSERTS TYPES AL - AK - AH - RN - AO

ECC Ref#	AVK #	500	1,000	5,000	10,000	25,000	50,000
ELS-632-80	ALS4-632-80						
ELS-632-130	ALS4-632-130						
ELS-832-80	ALS4-832-80						
ELS-832-130	ALS4-832-130						
ELS-1024-130	ALS4-1024-130						
ELS-1024-225	ALS4-1024-225						
ELS-1032-130	ALS4-1032-130						
ELS-1032-225	ALS4-1032-225						
ELS-420-165	ALS4-420-165						
ELS-420-260	ALS4-420-260						
ELS-428-165	ALS4-428-165						
ELS-428-260	ALS4-428-260						
ELS-518-150	ALS4-518-150						
ELS-518-312	ALS4-518-312						
ELS-524-150	ALS4-524-150						
ELS-524-312	ALS4-524-312						
ELS-616-150	ALS4-616-150						
ELS-616-312	ALS4-616-312						
ELS-624-150	ALS4-624-150						
ELS-624-312	ALS4-624-312						
EKS-632-80	AKS4-632-80						
EKS-632-130	AKS4-632-130						
EKS-832-80	AKS4-832-80						
EKS-832-130	AKS4-832-130						
EKS-1024-130	AKS4-1024-130						
EKS-1024-225	AKS4-1024-225						
EKS-1032-130	AKS4-1032-130						
EKS-1032-225	AKS4-1032-225						
EKS-420-165	AKS4-420-165						
EKS-420-260	AKS4-420-260						
EKS-428-165	AKS4-428-165						
EKS-428-260	AKS4-428-260						
EKS-518-150	AKS4-518-150						

100,000 Price — 5% From 50m Column
 250,000 Price — 10% From 50m Column
 Many other Series and Parts Available on Request

AP-AR-AS-AT-AW Series — Specials — Tools
 These Parts Are Not Manufactured By AVK
 AVK is a Registered Trade Mark of Emhart

Engineered Components

visit our web site for a video tour
www.engcomponents.com



AVK ALTERNATES RIVET NUTS SERRATED AND NON-SERRATED INSERTS

Types AL - AK - AH - RN - AO

ECC Ref#	AVK #	500	1,000	5,000	10,000	25,000	50,000
EKS-518-312	AKS4-518-312						
EKS-524-150	AKS4-524-150						
EKS-524-312	AKS4-524-312						
EKS-616-150	AKS4-616-150						
EKS-616-312	AKS4-616-312						
EKS-624-150	AKS4-624-150						
EKS-624-312	AKS4-624-312						
EHS-632-80	AHS4-632-80						
EHS-632-130	AHS4-632-130						
EHS-832-80	AHS4-832-80						
EHS-832-130	AHS4-832-130						
EHS-1024-130	AHS4-1024-130						
EHS-1024-225	AHS4-1024-225						
EHS-1032-130	AHS4-1032-130						
EHS-1032-225	AHS4-1032-225						
EHS-420-165	AHS4-420-165						
EHS-420-260	AHS4-420-260						
EHS-428-165	AHS4-428-165						
EHS-428-260	AHS4-428-260						
EHS-518-150	AHS4-518-510						
EHS-518-312	AHS4-518-312						
EHS-524-150	AHS4-524-150						
EHS-524-312	AHS4-524-312						
EHS-616-150	AHS4-616-150						
EHS-616-312	AHS4-616-312						
EHS-624-150	AHS4-624-150						
EHS-624-312	AHS4-624-312						
ERS-632-75	RNS-632-75						
ERS-632-120	RNS-632-120						
ERS-832-75	RNS-832-75						
ERS-832-120	RNS-832-120						

100,000 Price — 5% From 50m Column
 250,000 Price — 10% From 50m Column
 Many other Series and Parts Available on Request

AP-AR-AS-AT-AW Series — Specials — Tools
 These Parts Are Not Manufactured By AVK
 AVK is a Registered Trade Mark of Emhart



AVK ALTERNATES RIVET NUTS SERRATED AND NON-SERRATED INSERTS

Types AL - AK - AH - RN - AO

ECC Ref#	AVK #	500	1,000	5,000	10,000	25,000	50,000
ERS-832-160	RNS-832-160						
ERS-1024-130	RNS-1024-130						
ERS-1032-80	RNS-1032-80						
ERS-1032-130	RNS-1032-130						
ERS-1032-180	RNS-1032-180						
ERS-420-80	RNS-420-80						
ERS-420-140	RNS-420-140						
ERS-420-200	RNS-420-200						
ERS-420-260	RNS-420-260						
ERS-518-125	RNS-518-125						
ERS-518-200	RNS-518-200						
ERS-518-275	RNS-518-275						
ERS-616-115	RNS-616-115						
ERS-616-200	RNS-616-200						
ERS-616-285	RNS-616-285						
ERS-813-175	RNS-813-175						
ERS-813-250	RNS-813-250						
EOS-632-80	AOS3-632-80						
EOS-832-80	AOS3-832-80						
EOS-1024-130	AOS3-1024-130						
EOS-1032-130	AOS3-1032-130						
EOS-420-165	AOS3-420-165						
EOS-428-165	AOS3-428-165						
EOS-518-200	AOS3-518-200						
EOS-524-200	AOS3-524-200						
EOS-616-200	AOS3-616-200						
EOS-624-200	AOS3-624-200						

Many other Series and Parts Available on Request
 AP-AR-AS-AT-AW Series — Specials — Tools
 These Parts Are Not Manufactured By AVK
 AVK is a Registered Trade Mark of Emhart

Engineered Components

visit our web site for a video tour
www.engcomponents.com

SELF-CLINCHING STUDS Hardened Steel Zinc Plated



SIZES AVAILABLE	ECC PART #	1,000	2,500	5,000	10,000	25,000	50,000	100,000
4-40 x 1/4	EC-FH440-04-ALT							
4-40 X 3/8	EC-FH440-06-ALT							
4-40 X 1/2	EC-FH440-08-ALT							
4-40 X 5/8	EC-FH440-10-ALT							
4-40 X 3/4	EC-FH440-12-ALT							
6-32 X 1/4	EC-FH632-04-ALT							
6-32 X 5/16	EC-FH632-05-ALT							
6-32 X 3/8	EC-FH632-06-ALT							
6-32 X 1/2	EC-FH632-08-ALT							
6-32 X 5/8	EC-FH632-10-ALT							
6-32 X 3/4	EC-FH632-12-ALT							
6-32 X 1	EC-FH632-16-ALT							
6-32 X 1-1/4	EC-FH632-20-ALT							
8-32 X 1/4	EC-FH832-04-ALT							
8-32 X 5/16	EC-FH832-05-ALT							
8-32 X 3/8	EC-FH832-06-ALT							
8-32 X 1/2	EC-FH832-08-ALT							
8-32 X 5/8	EC-FH832-10-ALT							
8-32 X 3/4	EC-FH832-12-ALT							
8-32 X 7/8	EC-FH832-14-ALT							
8-32 X 1	EC-FH832-16-ALT							
8-32 X 1-1/4	EC-FH832-20-ALT							
8-32 X 1-1/2	EC-FH832-24-ALT							
10-24 X 3/8	EC-FH024-06-ALT							
10-24 X 1/2	EC-FH024-08-ALT							
10-24 X 5/8	EC-FH024-10-ALT							
10-24 X 3/4	EC-FH024-12-ALT							
10-24 X 7/8	EC-FH024-14-ALT							
10-24 X 1	EC-FH024-16-ALT							
10-24 X 1-1/4	EC-FH024-20-ALT							
10-24 X 1-1/2	EC-FH024-24-ALT							
10-32 X 3/8	EC-FH032-06-ALT							
10-32 X 1/2	EC-FH032-08-ALT							
10-32 X 5/8	EC-FH032-10-ALT							
10-32 X 3/4	EC-FH032-12-ALT							
10-32 X 7/8	EC-FH032-14-ALT							
10-32 X 1	EC-FH032-16-ALT							
10-32 X 1-1/4	EC-FH032-20-ALT							

"ALT" in our part number represents "Alternate."

The above items are not manufactured by PEM® or Penn Engineering.

Captive Fastener's Part Number is the same as Penn Engineering's, substituting the "FHS" with a "CHS".

®PEM is a registered trademark of Penn Engineering. Our clinch nuts and clinch studs are not manufactured by or connected with the producers of Penn Engineering's clinch nuts and clinch studs.

SELF-CLINCHING STUDS

Hardened Steel Zinc Plated

SIZES AVAILABLE	ECC PART #	1,000	2,500	5,000	10,000	25,000	50,000	100,000
1/4-20 X 1/2	EC-FH042-8-ALT							
1/4-20 X 5/8	EC-FH042-10-ALT							
1/4-20 X 3/4	EC-FH042-12-ALT							
1/4-20 X 7/8	EC-FH042-14-ALT							
1/4-20 X 1	EC-FH042-16-ALT							
1/4-20 X 1-1/8	EC-FH042-18-ALT							
1/4-20 X 1-1/4	EC-FH042-20-ALT							
1/4-20 X 1-1/2	EC-FH042-24-ALT							
1/4-20 X 2	EC-FH042-32-ALT							
5/16-18 X 3/4	EC-FH0518-12-ALT							
5/16-18 X 1	EC-FH0518-16-ALT							
5/16-18 X 1-1/4	EC-FH0518-20-ALT							
5/16-18 X 1-1/2	EC-FH0518-24-ALT							
5/16-18 X 1-3/4	EC-FH0518-28-ALT							

"ALT" in our part number represents "Alternate."

The above items are not manufactured by PEM® or Penn Engineering.

Captive Fastener's Part Number is the same as Penn Engineering's, substituting the "FHS" with a "CHS".

®PEM is a registered trademark of Penn Engineering. Our clinch nuts and clinch studs are not manufactured by or connected with the producers of Penn Engineering's clinch nuts and clinch studs.

Engineered Components

visit our web site for a video tour
www.engcomponents.com

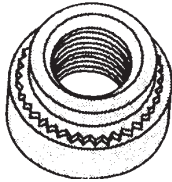

SELF-CLINCHING NUTS

Hardened Steel Zinc Plated

SIZES AVAILABLE	ECC PART #	1,000	2,500	5,000	10,000	25,000	50,000	100,000
4/40-0	S-440-0-ZI-ALT							
4/40-1	S-440-1-ZI-ALT							
4/40-2	S-440-2-ZI-ALT							
6/32-0	S-632-0-ZI-ALT							
6/32-1	S-632-1-ZI-ALT							
6/32-2	S-632-2-ZI-ALT							
8/32-0	S-832-0-ZI-ALT							
8/32-1	S-832-1-ZI-ALT							
8/32-2	S-832-2-ZI-ALT							
10/24-0	SS-024-0-ZI-ALT							
10/24-1	SS-024-1-ZI-ALT							
10/24-2	SS-024-2-ZI-ALT							
10/24-3	SS-024-3-ZI-ALT							
10/32-0	SS-032-0-ZI-ALT							
10/32-1	SS-032-1-ZI-ALT							
10/32-2	SS-032-2-ZI-ALT							
1/4-20-1	S-0420-1-ZI-ALT							
1/4-20-2	S-0420-2-ZI-ALT							
1/4-20-3	S-0420-3-ZI-ALT							
5/16-18-1	S-0518-1-ZI-ALT							
5/16-18-2	S-0518-2-ZI-ALT							
5/16-18-3	S-0518-3-ZI-ALT							
5/16-24-1	S-0524-1-ZI-ALT							
5/16-24-2	S-0524-2-ZI-ALT							

"ALT" in our part number represents "Alternate."

The above items are not manufactured by PEM® or Penn Engineering.

Captive Fastener's Part Number is the same as Penn Engineering's, substituting the "FHS" with a "CHS".

®PEM is a registered trademark of Penn Engineering. Our clinch nuts and clinch studs are not manufactured by or connected with the producers of Penn Engineering's clinch nuts and clinch studs.

JAK NUT ALTERNATES

Steel, Zinc
Threaded Inserts

WEL NUT ALTERNATES

Rubber, Brass Inserts
Threaded Inserts



JAK NUTS (ALT)
(In Stock)

PART #	GRIP	500	1,000	5,000	10,000	25,000	50,000
ECC 4SJN ALT	.015-.187 6/32						
ECC 4LJN ALT	.187-.375 6/32						
ECC 6SJN ALT	.015-.185 10/24						
ECC 6LJN ALT	.187-.375 10/24						
ECC 8SJN ALT	.015-.185 1/4-20						
ECC 8LJN ALT	.187-.375 1/4-20						
EC 8XLJN ALT	.375-.500 1/4-20						

WEL NUTS (ALT)

PART #	GRIP	500	1,000	5,000	10,000	25,000	50,000
ECC E632 ALT	.015-.156 6/32						
ECC B832 ALT	.015-.156 8/32						
ECC 10SL ALT	.308-.625 10/32						
ECC 10XL ALT	.800-1.170 10/32						
ECC 14S ALT	.015-.110 1/4-20						
ECC D1420 ALT	.030-.185 1/4-20						
EC E516.18 ALT	.015-.156 5/16-18						

ALT in our part number represents "ALTERNATE"
Our JAK and WEL nuts are not connected or manufactured by Emhart
The above parts ARE NOT manufactured by Emhart
JACK NUT and WELL NUT are registered Trade Marks of Emhart, Inc.

FOR ADDITIONAL SIZES SEE PAGES 00-00

visit our web site for a video tour
www.engcomponents.com

RUBBER NUT THREADED INSERTS (Brass Inserts)



Size	ECC Part #	Grip	1,000	2,500	5,000	10,000	25,000
6-32 S	EC0632-187S	.015 - .187					
8-32 S	EC0832-187S	.015 - .187					
10-32 S	EC1032-200S	.020 - .200					
10-32 F	EC1032-375F	.093 - .375					
10-32 R	EC1032-625R	.312 - .625					
1/4-20 SX	EC250-20-187SX	.031 - .187					
1/4-20 L	EC250-20-750L	.375 - .750					
5/16-18 S	EC312-18-150S	.024 - .150					
3/8-16 SX	EC375-16-406SX	.032 - .406					

The above sizes are available from stock.
 Many other sizes are available with a short lead time.
 See following page for specifications

COMPOSITE TRAILER PANEL BLIND RIVET

1/4" Dia. 105 to 136 Grip

Works On:

1. Dura Plate®
2. P Series Composite®
3. VXP®
4. Z Plate® All composite Plate Trailer

HOLE SIZE	MIN	.255
	RECOMMEND	.257 (F DRILL)
	MAX	.261
PLATE MIN HOLE DEPTH		.214
INSTALLATION TOOL		202
NOSE ASSEMBLY		99-3445-68
TYPICAL PROPERTIES (LBS)		
	TENSILE	400
	SHEAR	800

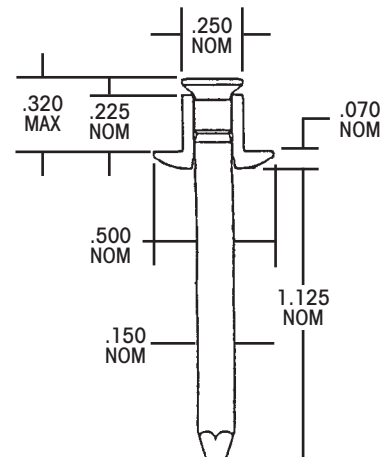
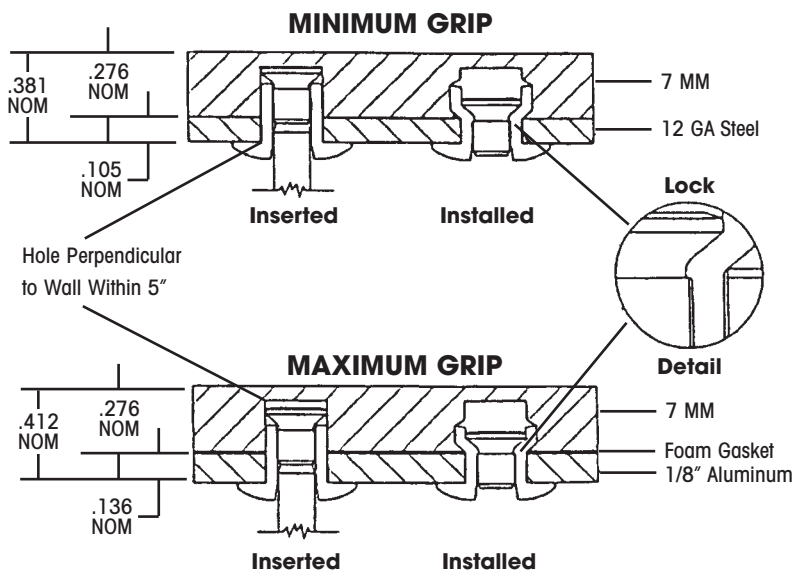

Dura Plate® is a registered trade mark of Wabash National
 P Series Composite® is a registered trade mark of Great Dane
 VXP Plate® is a registered trade mark of Vanguard National
 Z Plate® is a registered trade mark of Stoughton Trailer

RUBBER NUT SPECIFICATIONS SHEET



Size	ECC Part #	Grip	Diameter	Length	Head Diameter	Head Height
6-32 S	EC0632-187S	.015 - .187	.250	.562	.500	.062
6-32 R	EC0632-437R	.125 - .437	.250	.800	.500	.062
6-32 L	EC0632-625L	.312 - .625	.250	1.062	.500	.062
8-32 S	EC0832-187S	.015 - .187	.312	.562	.500	.062
8-23 L	EC0832-875L	.376 - .875	.312	1.312	.562	.062
10-32 S	EC1032-200S	.020 - .200	.375	.625	.562	.062
10-32 F	EC1032-375F	.093 - .375	.375	.860	.562	.040
10-32 R	EC1032-625R	.312 - .625	.375	1.062	.562	.062
10-32 L	EC1032-1125L	.750 - 1.125	.375	1.590	.625	.090
1/4-20 SX	EC250-20-187SX	.031 - .187	.500	.855	.750	.190
1/4-20 S	EC250-20-312S	.062 - .312	.500	.855	.875	.090
1/4-20 SXX	EC250-20-375SXX	.093 - .375	.500	.855	.625	.056
1/4-20 J	EC250-20-450J	.250 - .450	.500	1.062	.625	.051
1/4-20 R	EC250-20-625R	.375 - .625	.500	1.276	.875	.100
1/4-20 L	EC250-20-750L	.375 - .750	.500	1.840	1.000	.110
5/16-18 S	EC312-18-150S	.024 - .150	.620	.840	1.000	.110
5/16-18 R	EC312-18-750R	.250 - .750	.620	1.625	1.250	.125
3/8-16 SX	EC375-16-406SX	.032 - .406	.750	1.062	1.250	.190
3/8-16 S	EC375-16-437S	.024 - .437	.750	1.000	1.250	.125
3/8-16 R	EC375-16-750R	.250 - .750	.750	1.687	1.375	.150

Ariel Pierce-&-Roll Riveting System

Pierce and Roll System handles a wide range of materials and thickness of materials

Head form can be flush or raised, and the finish options include painting and plating

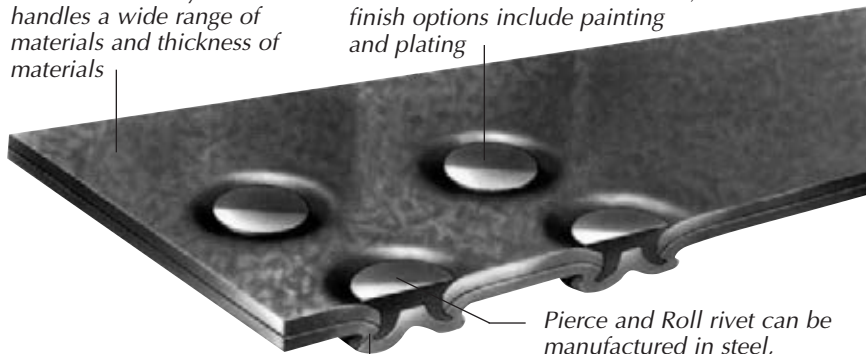

Pierce and Roll rivet can be manufactured in steel, Stainless Steel, and Aluminum

Non breakthrough, leaving protective finish intact

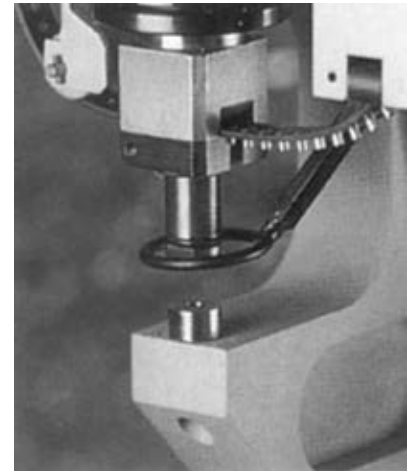

Shows a Sectional View of a Pierce-&-Roll™ Rivet

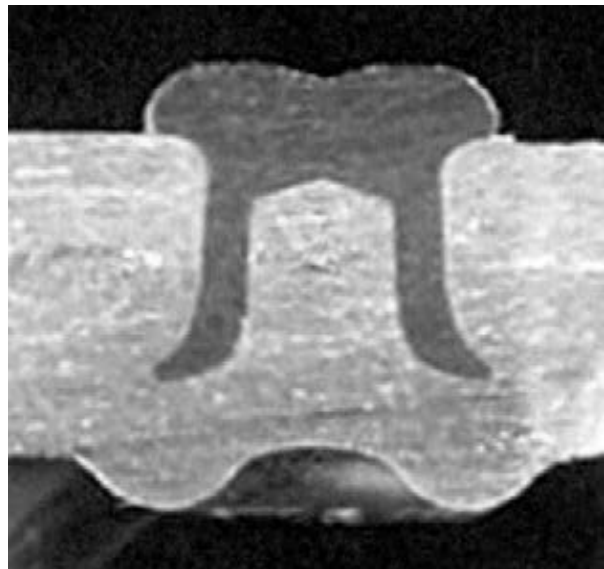
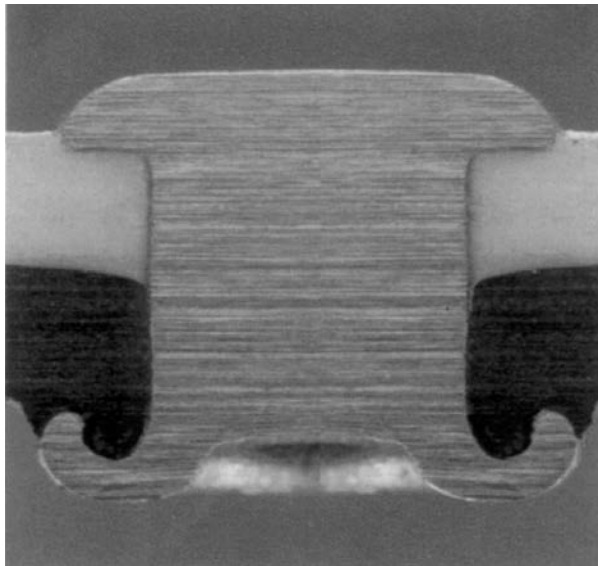

Engineered Components

847-841-7000 • Fax 847-841-7007

BLIND AND STRUCTURAL RIVETS

The Following is a Partial List of Blind Rivets We Carry in Stock at All Times at **VERY** Competitive Prices



POP	
ADS 66	SD616BS
SD66BSLF	SD46BS
SD812BS	SD45BS

SOUTHCO	
10-13-706-13	38-106-04-16
30-20-542-25	38-206-02-16
38-104-02-13	

HUCK	
MGLP-B6-4	MGLP-U6-4
MGLP-B8-6	MGLP-U8-6
MGLP-B8-10	MGLP-U8-10
MGLP-R6-4	MGL100-R8-8
MGLP-R8-6	MBCP-R8-M3
MGLP-R8-10	

AVDEL / CHERRY	
SSPV 86	BAPV 86
SSPI 86	BAPI 86
SSPV 810	BAPI 810
SSPI 810	AAP 66

The above is a **partial listing** of blind rivets sold on a regular basis.



Solid Aluminum Rivets Universal Head 2117 T4

Size	Part #	10#	25#	50#	100#	250#	500#	1,000#
3/16x3/8								
3/16x7/16	F6180309-27							
3/16x1/2								
3/16x9/16	F6180389-27							
1/4x7/16	F6181309-27							
1/4x1/2	F6181349-27							
1/4x9/16	F6181389-27							
1/4x5/8								
1/4x3/4	F6181509-27							
3/8x3/4	F6183509-27							



Solid Stainless Steel Rivets Universal Head 302 (18-8)

Size	Part #	10#	25#	50#	100#	250#	500#	1,000#
3/16x7/16								
1/4x1/2	F6181349-19							
1/4x9/16	F6181389-19							

ALL PRICES PER POUND



Engineered Components

visit our web site for a video tour
www.engcomponents.com

PALNUT® FASTENERS

High Performance, Low Cost, and Lightweight

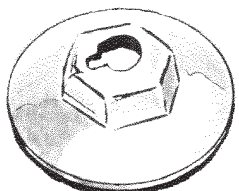
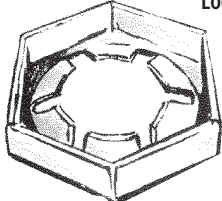
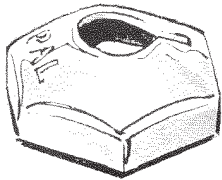
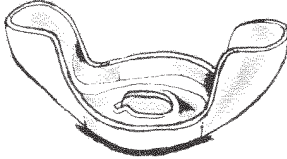
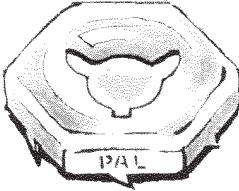
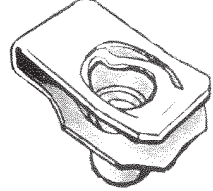
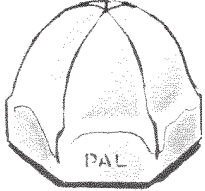
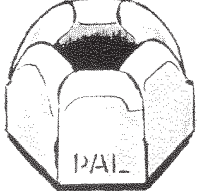
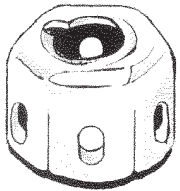
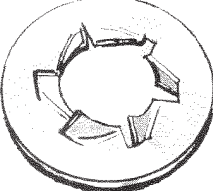
Palnut fasteners, manufactured from precision high carbon spring steel, save in initial cost, assembly time, weight and space over alternative fasteners. Palnut fasteners are available in two major groups — for threaded applications and non-threaded applications.

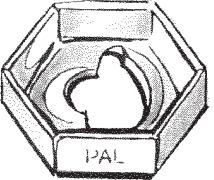
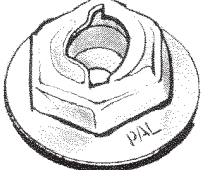
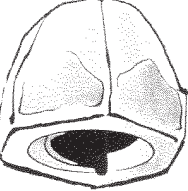
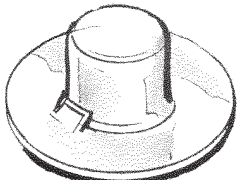
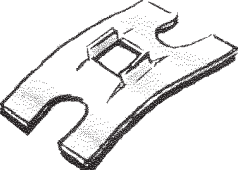
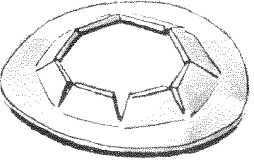
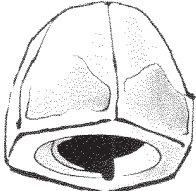
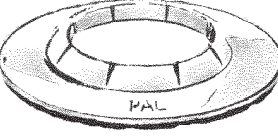
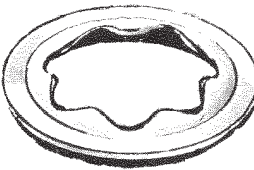
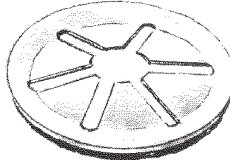
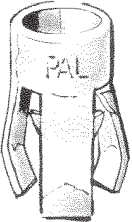
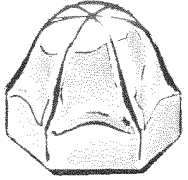
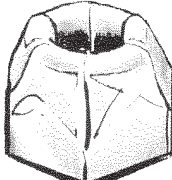
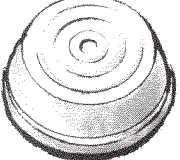
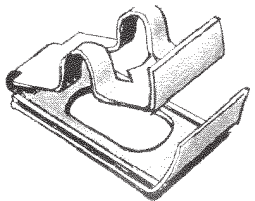
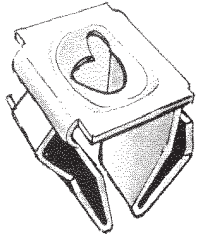
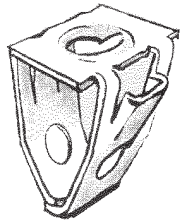
FOR THREADED APPLICATIONS				NEW INSERT TYPE NUTS
<p style="text-align: center;">Lock nuts</p> <div style="display: flex; justify-content: space-around;"> <div style="text-align: center;">  Washer/capped washer types </div> <div style="text-align: center;">  Regular type </div> <div style="text-align: center;">  Inverted type </div> <div style="text-align: center;">  Wing type </div> </div> <div style="display: flex; justify-content: space-around; margin-top: 10px;"> <div style="text-align: center;">  Tension nuts </div> <div style="text-align: center;">  Multi-thread U-nuts </div> <div style="text-align: center;">  Acorn type/closed top </div> <div style="text-align: center;">  Acorn type/open top </div> </div>				<p style="text-align: center;">On-sert® fasteners</p> <div style="text-align: center;">  Pushnut® bolt retainers </div> <div style="text-align: center; margin-top: 10px;">  </div>
<p style="text-align: center;">FOR NON-THREADED APPLICATIONS</p> <div style="display: flex; justify-content: space-between;"> <div style="width: 25%;"> <p style="text-align: center;">Self-threading nuts</p> <div style="text-align: center;">  Wing type </div> <div style="text-align: center; margin-top: 10px;">  Regular/inverted types </div> <div style="text-align: center; margin-top: 10px;">  Washer/capped washer types </div> <div style="text-align: center; margin-top: 10px;">  Acorn type </div> </div> <div style="width: 25%;"> <p style="text-align: center;">Pushnut® fasteners</p> <div style="text-align: center;">  Washer capped type </div> <div style="text-align: center; margin-top: 10px;">  Arched rectangular type </div> <div style="text-align: center; margin-top: 10px;">  Arched round type </div> <div style="text-align: center; margin-top: 10px;">  Acorn type </div> </div> <div style="width: 25%;"> <p style="text-align: center;">Flat round type</p> <div style="text-align: center;">  Flat round type </div> <div style="text-align: center; margin-top: 10px;">  Flat round type </div> <div style="text-align: center; margin-top: 10px;">  Flat round type </div> <div style="text-align: center; margin-top: 10px;">  Blind type </div> </div> <div style="width: 25%;"> <p style="text-align: center;">Acorn type/closed top</p> <div style="text-align: center;">  Acorn type/closed top </div> <div style="text-align: center; margin-top: 10px;">  Acorn type/open top </div> <div style="text-align: center; margin-top: 10px;">  Colored cap type (plastic) </div> <div style="text-align: center; margin-top: 10px;">  Removable type </div> </div> </div>				<p style="text-align: center;">NEW INSERT TYPE NUTS</p> <p style="text-align: center;">For metal and plastic panels. Accepts 4.2mm or #8-18 self tapping screw.</p> <div style="text-align: center;">   </div>

For additional information or samples for testing, write or call us



The Following is a Partial Listing of Palnut Parts We Stock

DO102410 SOH
DO832010 SOH
DO832075 SOH
DE832075 SOH
JZ001663 NOE
KD102410 NOE
LUGS060023 PG
LUGS142059 PG
LUGS561863 PG
LUGS103239 EBF
NR818005 SOH
PA125306 SOG
PD156307 SOG
PD156007 SOG
PS094032 PG
PS125006 SOH
PS125306 SOG
PS188007 SOG
PS250085 SOH
PS250385 SOG

PS312010 SOH
PS312310 SOH
PS375012 SOH
PS438014 SOH
PS500016 SOH
PT250008 PG
PT312010 PG
PT438135 PG
PV375615 SOH
PW250009 SOH
PW312010 SOH
PW3375011 SOH
PW500015 SOH
PZ002015 SCH
RF121300 SOH
RL341600 SOH
SD125085 SCH
SD188008 SOH
SD250011 SOH



**PLEASE CALL US ON ANY OTHER
PALNUT REQUIREMENTS
YOU MIGHT HAVE**

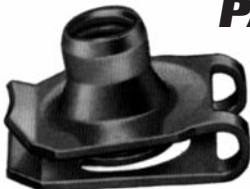

Engineered Components

visit our web site for a video tour
www.engcomponents.com

TINNERMAN®

The following is a partial listing of the Tinnerman® parts that we keep in stock on an ongoing basis

NUT RETAINERS (PARTIAL LISTING)

D-7888-1420	C-7941-1032	C-31175-5618
D-7931-832	D-7953-5618	D-31365-1420
D-7931-1024	D-7956-1420	C-31758-1032
D-7931-1032	D-7957-3816	D-31758-M508
D-7935-3816	D-7957-5618	C-33892-1420
D-7937-3816	D-7998-M61	C-33924-1420
D-7937-5618	D-7998-1420	C-33945-1420
D-7941-1024	C-30110-1420	C-33952-5618

PLASTIC PUSH ON AXLE CAPS (PARTIAL LISTING) (The middle number is the shaft size)

C-60002-187-805	C-60008-250-805	C-60008-375-805
C-60002-250-805	C-60008-312-805	

ROUND PUSH ON TYPE (PARTIAL LISTING)

C-12041-012	C-13727-014	C-18234-156
C-12043-012	C-14100-010	C-18234-187
C-12044-017	C-17022SS-010	

U-NUTS (PARTIAL LISTING)

D-521-1420	D-5207-014	D-8103-832
C-575-1024	C-8032SS-832	D-9031-8
D-1303-1420	C-8031-832	D-27091-014
C-1505-1032	D-8091-632	C-45931-014

FLAT TYPE (PARTIAL LISTING)

C-166-1420	C-7000-832	C-7000-1420
C-7000-8	C-7000-1024	C-9816-014
C-7000-10		

GROOVELESS RETAINING RINGS (PARTIAL LISTING)

T99220-68-576	T99220SS-58-576	T99220-120-576
T99220-91-576	T99220SS-104-576	

NOTE 1: The finishes have not been added to the part number.
 EXAMPLE -4PHOS, -3B ZINC. We can add or convert any plating or paint to whatever is needed.

NOTE 2: The "D" means the part is made in Canada (Dominion). The "C" means the part is made in Cleveland.

**PLEASE CALL US ON ANY OTHER
 TINNERMAN® REQUIREMENTS
 YOU MIGHT HAVE**

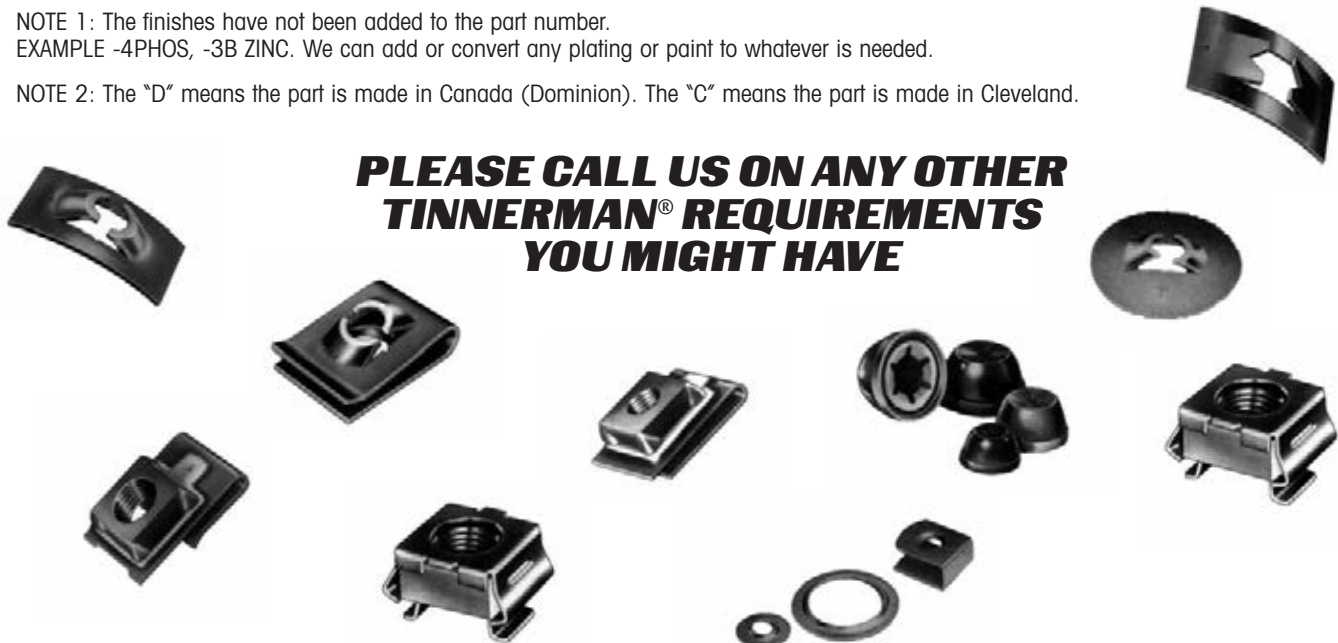

Engineered Components

847-841-7000 • Fax 847-841-7007

TINNERMAN PALNUT
ENGINEERED PRODUCTS, INC

For more than 60 years, Tinnerman has excelled
at meeting the individuals need for unquely
designed fasteners and retaining rings.



Positive Lock Wiring, Pipe and Cable Retainers

TRW is a major supplier of tried and tested, reliable wiring, pipe and cable retainers for industrial applications. We also offer a line of more focused retainers such as relay and connector retainers, tape on retainers, and fuel and brake line clips.

Shown below are standard tooled retainers readily available from our warehouse. Please contact us for samples or application engineering assistance.

Benefits and Advantages:

- Simple, easy assembly
- Wide range of wire harness sizes
- Broad range of application thickness
- Ease of removal for service
- Positive mounting
- Positive wire harness positioning
- Positive lock
- Prevents wire damage
- Optional application hole sealing



TRW retainers secure sensor cables

PC 92167
Cable retainer with wire position tabs for up to .375" bundle — ratchet leg for .250 hole



PC 47636
Wire bundle, pipe, cable or conduit strap — positive lock retention — ratchet leg for .250 hole — max. bundle dia. 1.5"

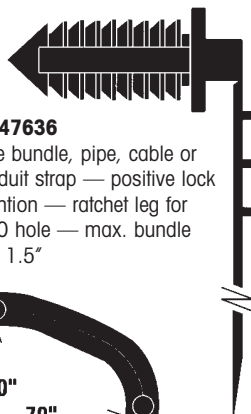

PC 92010
Multi-wire retainer — flat base — 2 holes for 2 heat stake studs

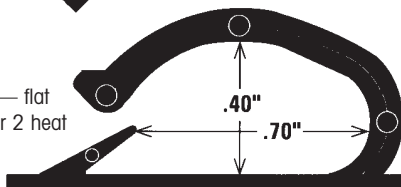

PC 96690
Wire, cable retainer — stop for edge mounting — ratchet leg for .250 hole — flex tab for anti-rattle



PC 96712
Pipe, cable or conduit retainer for two .125" rods — ratchet leg for .250 hole

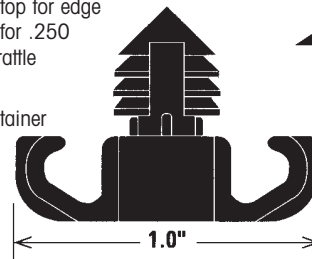

PC 92000
Tubing, clip with stand-off for positive positioning — ratchet mounting leg for .250 hole

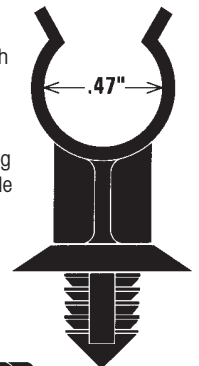

PC 96979
Rigid pipe clip with quick, easy flex mounting leg — fits .275 square hole

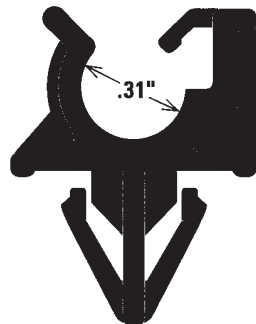

PC 92020
Large flange secures insulation combined with wire & cable — ratchet leg for .250 hole

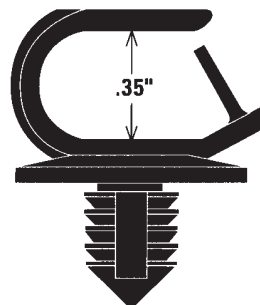

PC 92087
Wire & cable container traps wire flush to panel. Insertion in .236 hole made easy with reverse leg fastener

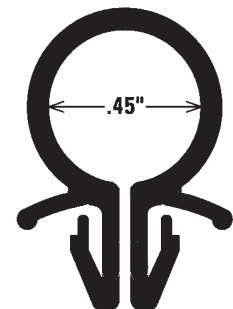

PC 92021
Large pipe & cable retainer, hinge, snap tight lock — ratchet leg for .250 hole

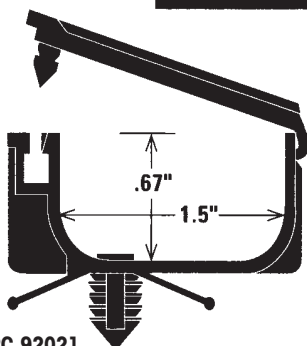

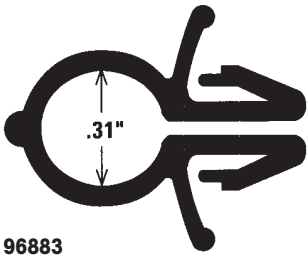

PC 96883
Wire & cable container traps wire flush to panel. Insertion in .236 hole made easy with reverse leg fastener

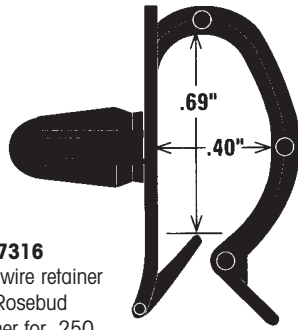

PC 47316
Multi-wire retainer with Rosebud fastener for .250 hole — wire & fastener easily removed

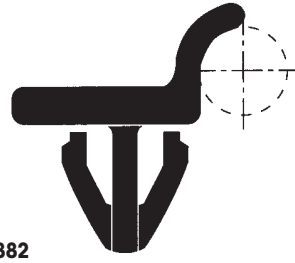

PC 96882
Wire harness clamp with positive flexible mounting leg — fits a .275 diameter hole — part holds 5/16" wire in corner

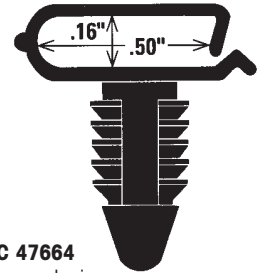

PC 47664
Compact wire retainer cables easily inserted and holds fast — ratchet leg is for a .250 hole

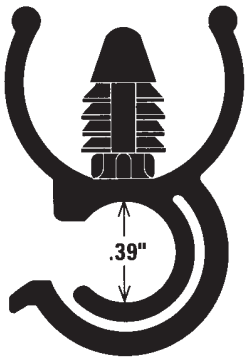

PC 47598
Conduit retainer with .250 leg for attachment to 3/4" tubing

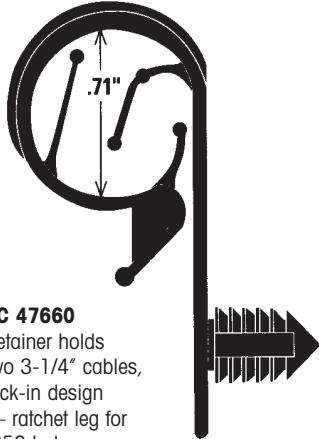

PC 47660
Retainer holds two 3-1/4" cables, lock-in design — ratchet leg for .250 hole

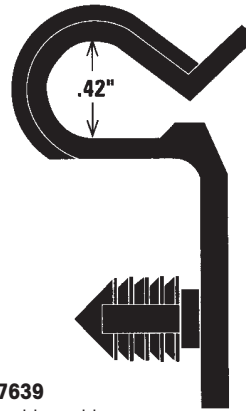

PC 47639
Rigid cable and harness retainer for edge mounting — ratchet leg for .250 hole

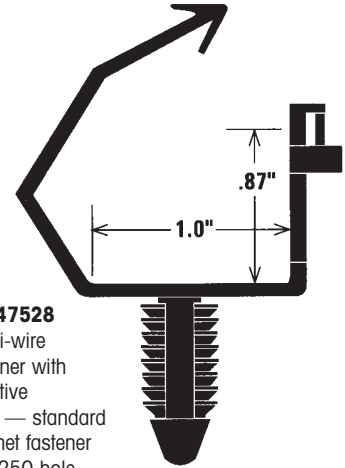

PC 47528
Multi-wire retainer with positive lock — standard ratchet fastener for .250 hole

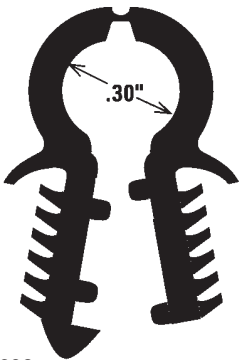

PC 47693
Convoluted retainer for 1/4" to 3/8" wire bundle or conduit — snap together ratchet fits .250 hole

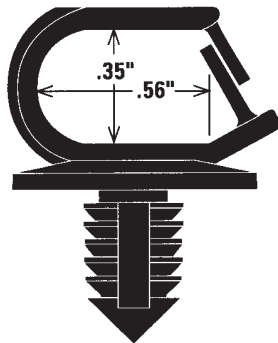

PC 47637
Multi-wire retainer with positive retention finger locks — ratchet leg for .250 hole

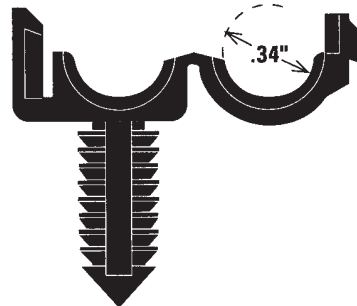

PC 47667
Convoluted retainer with hinge and snap lock, can be disengaged — ratchet leg for .250 hole — part holds 1/4" to 3/8" bundle

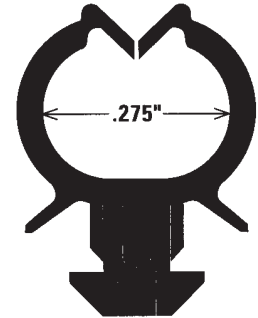

PC 47640
Miniature wire retainer for circuit boards & thin panels — snap-in leg fits .157 hole (non removable) — panel thickness .065

Engineered Components

visit our web site for a video tour
www.engcomponents.com

**FASTEX® ALTERNATES
 CHRISTMAS TREE CLIPS
 AND RATCHET RIVETS**

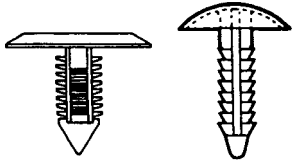

ECC REF. #	FASTEX #	1,000	3,000	5,000	10,000	25,000
80020071	354-250103-00					
30020071	354-250303-00					
90040071	354-280307-00					
1040071	354-280308-00					
11040071	354-162200-00					
21040071	M39-0630-10					
12010071	354-200101-00					
31040071	354-156001-00					
62020071	354-120240-00					
41040071	354-220000-00					
42010071	354-190001-00					
51040071	354-190001-01					
61040071	354-280317-00					
02010071	354-200102-00					
612021	354-280301-00					
712021	354-280305-00					
003021	236-170406-00					
203021	236-170406-02					
303021	236-170406-03					
403021	236-170406-04					
503021	236-170406-05					
703021	236-170406-07					
803021	236-170406-08					
903021	236-170406-09					
023021	236-220604-00					
523021	236-220603-00					
723021	236-220603-02					
923021	236-220603-10					

The Above Parts Are Not Manufactured by Fastex®
 Fastex® is a Registered Trademark of ITW
 \$25.00 Line Minimum \$50.00 Order Minimum
 Pricing is for Natural add \$3.00/m for black

Engineered Components

847-841-7000 • Fax 847-841-7007

GRAPHICS

Labels and Graphics Up to 48 Inches High
Same Day Shipment

*These are illustrations only
Thousand of standards available including your Special Design*

IMPORTANT

AFTER THE FIRST 50 TO 100
MILES OF SERVICE THE CAPNUT
TORQUE MUST BE TIGHTENED
TO 450-550FT. LBS.

TP-95

CAUTION

**HUBS ARE GREASE
FILLED
USE ONLY SYNTHETIC
GREASE**

LESSEE'S RESPONSIBILITY

MAINTAIN COLD TIRE INFLATION PRESSURE OF 105 PSI
(UNLESS OTHERWISE RECOMMENDED BY MANUFACTURER'S LOAD LIMIT TABLES)

CHECK OIL DAILY

JAN	FEB	DOT	1998	1999
MAR	APR		2000	2001
MAY	JUN	MANUFACTURED IN	2002	2003
JUL	AUG	(punch out)	2004	2005
SEP	OCT		2006	2007
NOV	DEC		2008	2009



Engineered Components

visit our web site for a video tour
www.engcomponents.com

PLYWOOD OR LUWAN PANELS, FIBERGLASS ONE SIDE

4 Feet x 8 Feet

LINER PANELS

SIZES AVAILABLE	Number of Panels				
	10	20	30	50	100
1/4" .030 Fiberglass Smooth					
1/4" .050 Fiberglass Smooth					
1/4" .030 Fiberglass Pebbled					
1/4" .050 Fiberglass Pebbled					
3/8" .030 Fiberglass Smooth					
3/8" .050 Fiberglass Smooth					
3/8" .030 Fiberglass Pebbled					
3/8" .050 Fiberglass Pebbled					
1/2" .030 Fiberglass Smooth					
1/2" .050 Fiberglass Smooth					
1/2" .030 Fiberglass Pebbled					
1/2" .050 Fiberglass Pebbled					

O.S.B. BOARD (pressboard)

4 Feet x 8 Feet

SIZES AVAILABLE	Number of Panels				
	10	20	30	50	100
1/4" .030 Fiberglass Smooth					
1/4" .050 Fiberglass Smooth					
1/4" .030 Fiberglass Pebbled					
1/4" .050 Fiberglass Pebbled					
3/8" .030 Fiberglass Smooth					
3/8" .050 Fiberglass Smooth					
3/8" .030 Fiberglass Pebbled					
3/8" .050 Fiberglass Pebbled					
1/2" .030 Fiberglass Smooth					
1/2" .050 Fiberglass Smooth					
1/2" .030 Fiberglass Pebbled					
1/2" .050 Fiberglass Pebbled					

For less than 10 panels, add 25%
 For less than 5 panels, add 35%

Other size panels available including
 pre-painted steel or aluminum laminated on
 plywood luwan O. S. B. plastic core, hollow
 core and other special cores

Engineered Components

847-841-7000 • Fax 847-841-7007



ZIP LOCK BAGS AND TAPE

SIZES AVAILABLE	PART #	CTN QTY	1 CNT	3 CNT	9 CNT
3x4	F9999890-00	1,000			
4x6	F9999930-00	1,000			
6x8	F9998991-00	1,000			
8x10	F9998992-00	1,000			
13x15	F9998993-00	1,000			

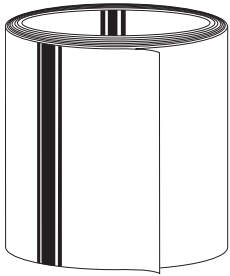

TAPE

SIZES AVAILABLE	PART #				
		1 Case	5 Case	10 Case	25 Case
Mylar					
2" Mylar Clear (36 Rolls/Case)	F9900749-0015				
3" Mylar Clear (24 Rolls/Case)	F9900819-0015				
5" Mylar Clear (12 Rolls/Case) <i>Heavy Duty</i>	F9900920-015				
Masking					
3/4" Masking Tape (48 Rolls/Case)	F9900509-0002				
4" Masking Tape (12 Rolls/Case)	F9900890-0002				

\$25.00 Line Minimum \$50.00 Order Minimum

ELECTRICAL TAPE

SIZES AVAILABLE	PART #				
		1 Case	5 Case	10 Case	25 Case
3/4" Electrical Tape 66ft per roll					

Many other sizes available upon request

Engineered Components

847-841-7000 • Fax 847-841-7007

TORX PLUS® MACHINE SCREWS Steel-Zinc Plated



Steel, Zinc Plated Machine Screws	ECC Part #	1,000	2,000	3,000	4,000	5,000	10,000	25,000	50,000	100,000
00-90 x 1/8 TORX PLUS® Pan Head	F8758-2738P									
00-90 x 3/16 TORX PLUS® Pan Head	F8759-3738P									
00-90 x 1/4 TORX PLUS® Pan Head	F8760-4738P									
00-80 x 1/8 TORX PLUS® Pan Head	F8761-5738P									
00-80 x 3/16 TORX PLUS® Pan Head	F8762-6738P									
00-80 x 1/4 TORX PLUS® Pan Head	F8763-7738P									
00-80 x 3/8 TORX PLUS® Pan Head	F8764-8738P									
1-64 x 1/8 TORX PLUS® Pan Head	F8765-9738P									
1-64 x 3/16 TORX PLUS® Pan Head	F8766-0838P									
1-64 x 1/4 TORX PLUS® Pan Head	F8767-1838P									
1-64 x 5/16 TORX PLUS® Pan Head	F8768-2838P									
1-64 x 3/8 TORX PLUS® Pan Head	F8769-3838P									
2-56 x 3/16 TORX PLUS® Pan Head	F8770-4838P									
2-56 x 1/4 TORX PLUS® Pan Head	F8771-5838P									
2-56 x 1/4 TORX PLUS® Flat Head	F8772-038F									
2-56 x 5/16 TORX PLUS® Pan Head	F8773-6838P									
2-56 x 5/16 TORX PLUS® Flat Head	F8774-058P									
2-56 x 3/8 TORX PLUS® Pan Head	F8775-8838P									
2-56 x 1/2 TORX PLUS® Pan Head	F8776-9838P									
3-48 x 1/4 TORX PLUS® Pan Head	F8777-0938P									
3-48 x 5/16 TORX PLUS® Pan Head	F8778-1938P									
3-48 x 3/8 TORX PLUS® Pan Head	F8779-2938P									
3-48 x 1/2 TORX PLUS® Pan Head	F8780-3938P									
4-40 x 1/4 TORX PLUS® Pan Head	F8781-4938P									
4-40 x 1/4 TORX PLUS® Flat Head	F8782-138F									
4-40 x 5/16 TORX PLUS® Pan Head	F8783-5938P									
4-40 x 3/8 TORX PLUS® Pan Head	F8784-6938P									
4-40 x 3/8 TORX PLUS® Flat Head	F8785-238F									
4-40 x 1/2 TORX PLUS® Pan Head	F8786-7938P									
4-40 x 1/2 TORX PLUS® Flat Head	F8787-338F									
4-40 x 3/4 TORX PLUS® Pan Head	F8788-8938P									
4-40 x 1 TORX PLUS® Pan Head	F8789-9938P									
5-40 x 1/4 TORX PLUS® Pan Head	F8790-0048P									
5-40 x 3/8 TORX PLUS® Pan Head	F8791-1048P									
5-40 x 1/2 TORX PLUS® Pan Head	F8792-2048P									
5-40 x 3/4 TORX PLUS® Pan Head	F8793-3048P									
5-40 x 1 TORX PLUS® Pan Head	F8794-4048P									
6-32 x 1/4 TORX PLUS® Pan Head	F8795-5048P									
6-32 x 5/16 TORX PLUS® Pan Head	F8796-6048P									
6-32 x 3/8 TORX PLUS® Pan Head	F8797-7048P									
6-32 x 3/8 TORX PLUS® Flat Head	F8798-438F									
6-32 x 1/2 TORX PLUS® Pan Head	F8799-8048P									
6-32 x 1/2 TORX PLUS® Flat Head	F8800-538F									
6-32 x 5/8 TORX PLUS® Pan Head	F8801-9048P									
6-32 x 3/4 TORX PLUS® Pan Head	F8802-0148P									
6-32 x 1 TORX PLUS® Pan Head	F8803-1148P									

Torx® is a Registered Trademark of Camcar Textron

Engineered Components

visit our web site for a video tour
www.engcomponents.com



TORX PLUS® MACHINE SCREWS

Steel-Zinc Plated

Steel, Zinc Plated Machine Screws	ECC Part #	1,000	2,000	3,000	4,000	5,000	10,000	25,000	50,000	100,000
6-32 x 1 TORX PLUS® Flat Head	F8804-638F									
8-32 x 1/4 TORX PLUS® Pan Head	F8805-2148P									
8-32 x 5/16 TORX PLUS® Pan Head	F8806-3148P									
8-32 x 3/8 TORX PLUS® Pan Head	F8807-4148P									
8-32 x 3/8 TORX PLUS® Flat Head	F8808-738F									
8-32 x 1/2 TORX PLUS® Pan Head	F8809-5148P									
8-32 x 1/2 TORX PLUS® Flat Head	F8810-838F									
8-32 x 5/8 TORX PLUS® Pan Head	F8811-6148P									
8-32 x 3/4 TORX PLUS® Pan Head	F8812-7148P									
8-32 x 1 TORX PLUS® Pan Head	F8813-8148P									
10-24 x 3/8 TORX PLUS® Pan Head	F8814-9148P									
10-24 x 1/2 TORX PLUS® Pan Head	F8815-0248P									
10-24 x 5/8 TORX PLUS® Pan Head	F8816-1248P									
10-24 x 3/4 TORX PLUS® Pan Head	F8817-2248P									
10-24 x 1 TORX PLUS® Pan Head	F8818-3248P									
10-32 x 3/8 TORX PLUS® Pan Head	F8819-4248P									
10-32 x 1/2 TORX PLUS® Pan Head	F8820-5248P									
10-32 x 5/8 TORX PLUS® Pan Head	F8821-6248P									
10-32 x 3/4 TORX PLUS® Pan Head	F8822-7248P									
10-32 x 1 TORX PLUS® Pan Head	F8823-8248P									
12-24 x 3/8 TORX PLUS® Pan Head	F8824-9248P									
12-24 x 1/2 TORX PLUS® Pan Head	F8825-0348P									
12-24 x 3/4 TORX PLUS® Pan Head	F8826-1348P									
12-24 x 1 TORX PLUS® Pan Head	F8827-2348P									
1/4-20 x 1/2 TORX PLUS® Pan Head	F8828-3348P									
1/4-20 x 5/8 TORX PLUS® Pan Head	F8829-4348P									
1/4-20 x 3/4 TORX PLUS® Pan Head	F8830-5348P									
1/4-20 x 1 TORX PLUS® Pan Head	F8831-6348P									
1/4-20 x 1 1/4 TORX PLUS® Pan Head	F8832-7348P									
1/4-20 x 1 1/2 TORX PLUS® Pan Head	F8833-8348P									
5/16-18 x 1/2 TORX PLUS® Pan Head	F8834-9348P									
5/16-18 x 5/8 TORX PLUS® Pan Head	F8835-0448P									
5/16-18 x 3/4 TORX PLUS® Pan Head	F8836-1448P									
5/16-18 x 1 TORX PLUS® Pan Head	F8837-2448P									
5/16-18 x 1 1/4 TORX PLUS® Pan Head	F8838-3448P									
5/16-18 x 1 1/2 TORX PLUS® Pan Head	F8839-4448P									
5/16-18 x 1 3/4 TORX PLUS® Pan Head	F8840-5448P									
3/8-16 x 1/2 TORX PLUS® Pan Head	F8841-6448P									
3/8-16 x 5/8 TORX PLUS® Pan Head	F8842-7448P									
3/8-16 x 3/4 TORX PLUS® Pan Head	F8843-8448P									
3/8-16 x 1 TORX PLUS® Pan Head	F8844-9448P									

Torx® is a Registered Trademark of Camcar Textron

Engineered Components

847-841-7000 • Fax 847-841-7007

TORX PLUS® MACHINE SCREWS Steel-Zinc Plated



Steel, Zinc Plated Machine Screws	ECC Part #	1,000	2,000	3,000	4,000	5,000	10,000	25,000	50,000	100,000
3/8-16 x 1 1/4 TORX PLUS® Pan Head	F8845-0548P									
3/8-16 x 1 1/2 TORX PLUS® Pan Head	F8846-1548P									
7/16-14 x 1 TORX PLUS® Pan Head	F8847-2548P									
7/16-14 x 1 1/4 TORX PLUS® Pan Head	F8848-3548P									
7/16-14 x 1 1/2 TORX PLUS® Pan Head	F8849-4548P									
7/16-14 x 1 3/4 TORX PLUS® Pan Head	F8850-5548P									
1/2-13 x 1 TORX PLUS® Pan Head	F8851-6548P									
1/2-13 x 1 1/4 TORX PLUS® Pan Head	F8852-7548P									
1/2-13 x 1 1/2 TORX PLUS® Pan Head	F8853-8548P									
1/2-13 x 1 3/4 TORX PLUS® Pan Head	F8854-9548P									
1/2-13 x 1 TORX PLUS® Pan Head	F8855-0648P									
9/16-12 x 1 1/2 TORX PLUS® Pan Head	F8856-1648P									
9/16-12 x 2 TORX PLUS® Pan Head	F8857-2648P									
9/16-12 x 2 1/2 TORX PLUS® Pan Head	F8858-3648P									
5/8-11 x 1 1/2 TORX PLUS® Pan Head	F8859-4648P									
5/8-11 x 2 TORX PLUS® Pan Head	F8860-5648P									
5/8-11 x 2 1/2 TORX PLUS® Pan Head	F8861-6648P									
M1.6-0.35 x 3 mm TORX PLUS® Pan Head	F8862-7648P									
M1.6-0.35 x 4 mm TORX PLUS® Pan Head	F8863-8648P									
M1.6-0.35 x 5 mm TORX PLUS® Pan Head	F8864-9648P									
M1.6-0.35 x 6 mm TORX PLUS® Pan Head	F8865-0748P									
M1.6-0.35 x 8 mm TORX PLUS® Pan Head	F8866-1748P									
M2-0.4 x 4 mm TORX PLUS® Pan Head	F8867-2748P									
M2-0.4 x 4 mm TORX PLUS® Pan Head	F8868-938F									
M2-0.4 x 6 mm TORX PLUS® Pan Head	F8869-3748P									
M2-0.4 x 6 mm TORX PLUS® Pan Head	F8870-048F									

Torx® is a Registered Trademark of Camcar Textron

Engineered Components

visit our web site for a video tour
www.engcomponents.com



TORX PLUS® MACHINE SCREWS Steel-Zinc Plated

Steel, Zinc Plated Machine Screws	ECC Part #	1,000	2,000	3,000	4,000	5,000	10,000	25,000	50,000	100,000
M2-0.4 x 8mm TORX PLUS® Pan Head	F8871-4748P									
M2-0.4 x 10mm TORX PLUS® Pan Head	F8872-5748P									
M2.5-0.45 x 4mm TORX PLUS® Pan Head	F8873-6748P									
M2.5-0.45 x 5mm TORX PLUS® Pan Head	F8874-7748P									
M2.5-0.45 x 6mm TORX PLUS® Pan Head	F8875-8748P									
M2.5-0.45 x 6mm TORX PLUS® Flat Head	F8876-148F									
M2.5-0.45 x 8mm TORX PLUS® Pan Head	F8877-9748P									
M2.5-0.45 x 8mm TORX PLUS® Flat Head	F8878-248F									
M2.5-0.45 x 10mm TORX PLUS® Pan Head	F8879-0848P									
M2.5-0.45 x 12mm TORX PLUS® Pan Head	F8880-1848P									
M3-0.5 x 6mm TORX PLUS® Pan Head	F8881-2848P									
M3-0.5 x 8mm TORX PLUS® Flat Head	F8882-3848P									
M3-0.5 x 8mm TORX PLUS® Flat Head	F8883-348F									
M3-0.5 x 10mm TORX PLUS® Flat Head	F8884-4848P									
M3-0.5 x 12mm TORX PLUS® Pan Head	F8885-5848P									
M3-0.5 x 16mm TORX PLUS® Pan Head	F8886-6848P									
M3.5-0.6 x 6mm TORX PLUS® Pan Head	F8887-7848P									
M3.5-0.6 x 8mm TORX PLUS® Pan Head	F8888-8848P									
M3.5-0.6 x 10mm TORX PLUS® Pan Head	F8889-9848P									
M3.5-0.6 x 12mm TORX PLUS® Pan Head	F8890-0948P									
M3.5-0.6 x 16mm TORX PLUS® Pan Head	F8891-1948P									
M4-0.7 x 6mm TORX PLUS® Pan Head	F8892-2948P									
M4-0.7 x 8mm TORX PLUS® Pan Head	F8893-3948P									
M4-0.7 x 10mm TORX PLUS® Pan Head	F8894-4948P									
M4-0.7 x 12mm TORX PLUS® Pan Head	F8895-5948P									
M4-0.7 x 16mm TORX PLUS® Pan Head	F8896-6948P									

Torx® is a Registered Trademark of Camcar Textron

Engineered Components

847-841-7000 • Fax 847-841-7007

TORX PLUS® MACHINE SCREWS Steel-Zinc Plated



Steel, Zinc Plated Machine Screws	ECC Part #	1,000	2,000	3,000	4,000	5,000	10,000	25,000	50,000	100,000
M4-0.7 x 20mm TORX PLUS® Pan Head	F8897-7948P									
M4.5-0.75 x 10mm TORX PLUS® Pan Head	F8898-8948P									
M4.5-0.75 x 12mm TORX PLUS® Pan Head	F8899-9948P									
M4.5-0.75 x 16mm TORX PLUS® Pan Head	F8900-0058P									
M4.5-0.75 x 20mm TORX PLUS® Pan Head	F8901-1058P									
M4.5-0.75 x 25mm TORX PLUS® Pan Head	F8902-2058P									
M5-0.8 x 10mm TORX PLUS® Pan Head	F8903-3058P									
M5-0.8 x 12mm TORX PLUS® Pan Head	F8904-4058P									
M5-0.8 x 16mm TORX PLUS® Pan Head	F8905-5058P									
M5-0.8 x 20mm TORX PLUS® Pan Head	F8906-6058P									
M5-0.8 x 25mm TORX PLUS® Pan Head	F8907-7058P									
M6-1.0 x 12mm TORX PLUS® Pan Head	F8908-8058P									
M6-1.0 x 16mm TORX PLUS® Pan Head	F8909-9058P									
M6-1.0 x 20mm TORX PLUS® Pan Head	F8910-0158P									
M6-1.0 x 25mm TORX PLUS® Pan Head	F8911-1158P									
M6-1.0 x 30mm TORX PLUS® Pan Head	F8912-2158P									
M6-1.0 x 35mm TORX PLUS® Pan Head	F8913-3158P									
M8-1.25 x 16mm TORX PLUS® Pan Head	F8914-4158P									
M8-1.25 x 20mm TORX PLUS® Pan Head	F8915-5158P									
M8-1.25 x 25mm TORX PLUS® Pan Head	F8916-6158P									
M8-1.25 x 30mm TORX PLUS® Pan Head	F8917-7158P									
M8-1.25 x 35mm TORX PLUS® Pan Head	F8918-8158P									
M10-1.5 x 20mm TORX PLUS® Pan Head	F8919-9158P									
M10-1.5 x 25mm TORX PLUS® Pan Head	F8920-0258P									
M10-1.5 x 30mm TORX PLUS® Pan Head	F8921-1258P									

Torx® is a Registered Trademark of Camcar Textron

Engineered Components

visit our web site for a video tour
www.engcomponents.com

TORX PLUS® MACHINE SCREWS Steel-Zinc Plated



Steel, Zinc Plated Machine Screws	ECC Part #	1,000	2,000	3,000	4,000	5,000	10,000	25,000	50,000	100,000
M10-1.5 x 35 mm TORX PLUS® Pan Head	F8922-2258P									
M12-1.75 x 25 mm TORX PLUS® Pan Head	F8923-3258P									
M12-1.75 x 30 mm TORX PLUS® Pan Head	F8924-4258P									
M12-1.75 x 35mm TORX PLUS® Pan Head	F8925-5258P									
M12-1.75 x 40mm TORX PLUS® Pan Head	F8926-6258P									
M14-2.0 x 25mm TORX PLUS® Pan Head	F8927-7258P									
M14-2.0 x 30mm TORX PLUS® Pan Head	F8928-8258P									
M14-2.0 x 35mm TORX PLUS® Pan Head	F8929-9258P									
M14-2.0 x 40mm TORX PLUS® Pan Head	F8930-0358P									
M16-2.0 x 25mm TORX PLUS® Pan Head	F8931-1358P									
M16-2.0 x 30mm TORX PLUS® Pan Head	F8932-2358P									
M16-2.0 x 35mm TORX PLUS® Pan Head	F8933-3358P									
M16-2.0 x 40mm TORX PLUS® Pan Head	F8934-4358P									

Torx® is a Registered Trademark of Camcar Textron

Call For Pricing on Above

Engineered Components

847-841-7000 • Fax 847-841-7007



STAINLESS STEEL TORX PLUS® MACHINE SCREWS

Button Head
Pan Head
Flat Head
Socket Head Cap

Passivated Stainless Steel Machine Screws	ECC Part #	1,000	2,000	3,000	4,000	5,000	10,000	25,000	50,000	100,000
0-80 x 1/8 TORX PLUS® Button Head	F8701-119B									
0-80 x 1/8 TORX PLUS® Pan Head	F8702-339P									
0-80 x 1/4 TORX PLUS® Pan Head	F8703-239P									
2-56 x 3/16 TORX PLUS® Button Head	F8704-219B									
2-56 x 1/4 TORX PLUS® Pan Head	F8705-709P									
2-56 x 1/4 TORX PLUS® Socket Head Cap	F8706-409C									
4-40 x 1/8 TORX PLUS® Button Head	F8707-419B									
4-40 x 3/16 TORX PLUS® Button Head	F8708-319B									
4-40 x 1/4 TORX PLUS® Pan Head	F8709-739P									
4-40 x 1/4 TORX PLUS® Flat Head	F8710-709F									
4-40 x 1/4 TORX PLUS® Socket Head Cap	F8711-609C									
4-40 x 3/8 TORX PLUS® Socket Head Cap	F8712-509C									
4-40 x 1/2 TORX PLUS® Flat Head	F8713-809F									
6-32 x 1/4 TORX PLUS® Button Head	F8714-619B									
6-32 x 1/4 TORX PLUS® Pan Head	F8715-809P									
6-32 x 3/8 TORX PLUS® Pan Head	F8716-909P									
6-32 x 3/8 TORX PLUS® Button Head	F8717-519B									
6-32 x 1/2 TORX PLUS® Pan Head	F8718-019P									
6-32 x 1/2 TORX PLUS® Flat Head	F8719-009F									
6-32 x 1 TORX PLUS® Flat Head	F8720-109F									
8-32 x 1/4 TORX PLUS® Pan Head	F8721-409P									
8-32 x 3/8 TORX PLUS® Pan Head	F8722-509P									
8-32 x 1/2 TORX PLUS® Pan Head	F8723-609P									
8-32 x 1/2 TORX PLUS® Flat Head	F8724-209F									
M2-0.4 x 4mm TORX PLUS® Pan Head	F8725-539P									
M2-0.4 x 6mm TORX PLUS® Pan Head	F8726-639P									
M2-0.4 x 10mm TORX PLUS® Pan Head	F8727-439P									
M3-0.5 x 6mm TORX PLUS® Pan Head	F8728-009P									
M3-0.5 x 8mm TORX PLUS® Pan Head	F8729-109P									
M3-0.5 x 10mm TORX PLUS® Pan Head	F8730-209P									
M3-0.5 x 14mm TORX PLUS® Pan Head	F8731-309P									
M4-0.7 x 6mm TORX PLUS® Pan Head	F8732-939P									
M4-0.7 x 8mm TORX PLUS® Pan Head	F8733-049P									
M4-0.7 x 12mm TORX PLUS® Pan Head	F8734-839P									
M5-0.8 x 10mm TORX PLUS® Pan Head	F8735-329P									

Engineered Components

visit our web site for a video tour
www.engcomponents.com



TORX PLUS® MACHINE SCREWS WITH CREST CUP WASHERS

All Sizes Pan Head
 All Sizes Steel Zinc

Steel, Zinc Plated Machine Screws w/Crest Cup Washer	ECC Part #	1,000	2,000	3,000	4,000	5,000	10,000	25,000	50,000	100,000
2-56 x 1/4 TORX PLUS® Pan Head	F8736-428P									
2-56 x 3/8 TORX PLUS® Pan Head	F8737-528P									
4-40 x 1/4 TORX PLUS® Pan Head	F8738-558P									
4-40 x 3/8 TORX PLUS® Pan Head	F8739-838P									
4-40 x 1/2 TORX PLUS® Pan Head	F8740-458P									
6-32 x 1/4 TORX PLUS® Pan Head	F8741-338P									
6-32 x 3/8 TORX PLUS® Pan Head	F8742-438P									
6-32 x 1/2 TORX PLUS® Pan Head	F8743-538P									
6-32 x 3/4 TORX PLUS® Pan Head	F8744-638P									
6-32 x 1 TORX PLUS® Pan Head	F8745-738P									
8-32 x 1/4 TORX PLUS® Pan Head	F8746-038P									
8-32 x 3/8 TORX PLUS® Pan Head	F8747-138P									
8-32 x 1/2 TORX PLUS® Pan Head	F8748-238P									
10-32 x 3/8 TORX PLUS® Pan Head	F8749-828P									
10-32 x 1/2 TORX PLUS® Pan Head	F8750-928P									
1/4-20 x 1/2 TORX PLUS® Pan Head	F8751-628P									
M3-0.5 x 6mm TORX PLUS® Pan Head	F8752-348P									
M4-0.7 x 6mm TORX PLUS® Pan Head	F8753-248P									
M4-0.7 x 8mm TORX PLUS® Pan Head	F8754-938P									
M4-0.7 x 10mm TORX PLUS® Pan Head	F8755-148P									
M4-0.7 x 12mm TORX PLUS® Pan Head	F8756-048P									
M5-0.8 x 10mm TORX PLUS® Pan Head	F8757-728P									

Torx® is a Registered Trademark of Camcar Textron

Engineered Components

847-841-7000 • Fax 847-841-7007

TORX PLUS® TAPTITE® II THREAD-ROLLING FASTENERS Steel-Zinc Plated



Steel, Zinc Plated Taptite Fasteners	ECC Part #	1,000	2,000	3,000	4,000	5,000	10,000	25,000	50,000	100,000
00-90 x 1/8 TORX PLUS® Pan Head	F8935-0018P									
00-90 x 3/16 TORX PLUS® Pan Head	F8936-1018P									
00-90 x 1/4 TORX PLUS® Pan Head	F8937-2018P									
0-80 x 1/8 TORX PLUS® Pan Head	F8938-648P									
0-80 x 3/16 TORX PLUS® Pan Head	F8939-3018P									
0-80 x 1/4 TORX PLUS® Pan Head	F8940-748P									
0-80 x 5/16 TORX PLUS® Pan Head	F8941-4018P									
0-80 x 3/8 TORX PLUS® Pan Head	F8942-5018P									
0-80 x 1/2 TORX PLUS® Pan Head	F8943-548P									
1-64 x 1/8 TORX PLUS® Pan Head	F8944-6018P									
1-64 x 3/16 TORX PLUS® Pan Head	F8945-7018P									
1-64 x 1/4 TORX PLUS® Pan Head	F8946-8018P									
1-64 x 5/16 TORX PLUS® Pan Head	F8947-9018P									
1-64 x 3/8 TORX PLUS® Pan Head	F8948-0118P									
2-56 x 1/4 TORX PLUS® Pan Head	F8949-848P									
2-56 x 1/4 TORX PLUS® Flat Head	F8950-018F									
2-56 x 5/16 TORX PLUS® Pan Head	F8951-1118P									
2-56 x 3/8 TORX PLUS® Pan Head	F8952-2118P									
2-56 x 1/2 TORX PLUS® Pan Head	F8953-948P									
3-48 x 1/4 TORX PLUS® Pan Head	F8954-3118P									
3-48 x 5/16 TORX PLUS® Pan Head	F8955-4118P									
3-48 x 3/8 TORX PLUS® Pan Head	F8956-5118P									
3-48 x 1/2 TORX PLUS® Pan Head	F8957-6118P									
4-40 x 1/4 TORX PLUS® Pan Head	F8958-908P									
4-40 x 1/4 TORX PLUS® Flat Head	F8959-008P									
4-40 x 5/16 TORX PLUS® Pan Head	F8960-7118P									
4-40 x 3/8 TORX PLUS® Pan Head	F8961-018P									
4-40 x 1/2 TORX PLUS® Pan Head	F8962-118P									
4-40 x 5/8 TORX PLUS® Pan Head	F8963-8118P									
4-40 x 3/4 TORX PLUS® Pan Head	F8964-218P									
4-40 x 1 TORX PLUS® Pan Head	F8965-318P									
5-40 x 1/4 TORX PLUS® Pan Head	F8966-9118P									
5-40 x 5/16 TORX PLUS® Pan Head	F8967-0218P									
5-40 x 3/8 TORX PLUS® Pan Head	F8968-1218P									
5-40 x 1/2 TORX PLUS® Pan Head	F8969-2218P									
6-32 x 1/4 TORX PLUS® Pan Head	F8970-418P									
6-32 x 5/16 TORX PLUS® Pan Head	F8971-3218P									
6-32 x 3/8 TORX PLUS® Pan Head	F2811244-06									
6-32 x 1/2 TORX PLUS® Flat Head	F8973-618P									
6-32 x 1/2 TORX PLUS® Pan Head	F8974-108P									
6-32 x 5/8 TORX PLUS® Pan Head	F8975-4218P									
6-32 x 3/4 TORX PLUS® Pan Head	F8976-718P									
6-32 x 1 TORX PLUS® Pan Head	F8977-818P									
8-32 x 1/4 TORX PLUS® Pan Head	F8978-918P									
8-32 x 5/16 TORX PLUS® Pan Head	F8979-5218P									
8-32 x 3/8 TORX PLUS® Pan Head	F8980-028P									

Torx® is a Registered Trademark of Camcar Textron

Engineered Components

visit our web site for a video tour
www.engcomponents.com



TORX PLUS® TAPTITE® II THREAD-ROLLING FASTENERS Steel-Zinc Plated

Steel, Zinc Plated Taptite Fasteners	ECC Part #	1,000	2,000	3,000	4,000	5,000	10,000	25,000	50,000	100,000
8-32 x 3/8 TORX PLUS® Flat Head	F8981-118F									
8-32 x 1/2 TORX PLUS® Pan Head	F8982-128P									
8-32 x 5/8 TORX PLUS® Pan Head	F8983-6218P									
8-32 x 3/4 TORX PLUS® Pan Head	F8984-228P									
8-32 x 3/4 TORX PLUS® Flat Head	F8985-218F									
8-32 x 1 TORX PLUS® Pan Head	F8986-328P									
10-24 x 3/8 TORX PLUS® Pan Head	F8987-7218P									
10-24 x 1/2 TORX PLUS® Pan Head	F8988-8218P									
10-24 x 5/8 TORX PLUS® Pan Head	F8989-9218P									
10-24 x 3/4 TORX PLUS® Pan Head	F8990-0318P									
10-24 x 1 TORX PLUS® Pan Head	F8991-1318P									
10-32 x 3/8 TORX PLUS® Pan Head	F8992-058P									
10-32 x 3/8 TORX PLUS® Flat Head	F8993-318F									
10-32 x 1/2 TORX PLUS® Pan Head	F8994-2318P									
10-32 x 5/8 TORX PLUS® Pan Head	F8995-3318P									
10-32 x 3/4 TORX PLUS® Pan Head	F8996-4318P									
10-32 x 3/4 TORX PLUS® Flat Head	F8997-418F									
10-32 x 1 TORX PLUS® Pan Head	F8998-158P									
12-24 x 3/8 TORX PLUS® Pan Head	F8999-5318P									
12-24 x 1/2 TORX PLUS® Pan Head	F9000-6318P									
12-24 x 5/8 TORX PLUS® Pan Head	F9001-7318P									
12-24 x 3/4 TORX PLUS® Pan Head	F9002-8318P									
1/4-20 x 1/2 TORX PLUS® Pan Head	F9003-9318P									
1/4-20 x 3/4 TORX PLUS® Pan Head	F9004-0418P									
1/4-20 x 3/4 TORX PLUS® Flat Head	F9005-518F									
1/4-20 x 1 TORX PLUS® Pan Head	F9006-1418P									
1/4-20 x 1 1/2 TORX PLUS® Pan Head	F9007-2418P									
5/16-18 x 1/2 TORX PLUS® Pan Head	F9008-3418P									
5/16-18 x 5/8 TORX PLUS® Pan Head	F9009-4418P									
5/16-18 x 3/4 TORX PLUS® Pan Head	F9010-5418P									
5/16-18 x 1 TORX PLUS® Pan Head	F9011-6418P									
5/16-18 x 1 1/4 TORX PLUS® Pan Head	F9012-7418P									
5/16-18 x 1 1/2 TORX PLUS® Pan Head	F9013-8418P									
3/8-16 x 1/2 TORX PLUS® Pan Head	F9014-9418P									
3/8-16 x 3/4 TORX PLUS® Pan Head	F9015-0518P									
3/8-16 x 1 TORX PLUS® Pan Head	F9016-1518P									
3/8-16 x 1 1/4 TORX PLUS® Pan Head	F9017-2518P									
3/8-16 x 1 1/2 TORX PLUS® Pan Head	F9018-3518P									
7/16-14 x 1 TORX PLUS® Pan Head	F9019-4518P									
7/16-14 x 1 1/2 TORX PLUS® Pan Head	F9020-5518P									
7/16-14 x 1 3/4 TORX PLUS® Pan Head	F9021-6518P									
7/16-14 x 2 TORX PLUS® Pan Head	F9022-7518P									
1/2-13 x1 TORX PLUS® Pan Head	F9023-8518P									
1/2-13 x1 1/2 TORX PLUS® Pan Head	F9024-9518P									
1/2-13 x 2 TORX PLUS® Pan Head	F9025-0618P									

Torx® is a Registered Trademark of Camcar Textron

TORX PLUS® TAPTITE® II THREAD-ROLLING FASTENERS Steel-Zinc Plated



Steel, Zinc Plated Taptite Fasteners	ECC Part #	1,000	2,000	3,000	4,000	5,000	10,000	25,000	50,000	100,000
9/16-12 x 1 1/2 TORX PLUS® Pan Head	F9026-1618P									
9/16-12 x 2 TORX PLUS® Pan Head	F9027-2618P									
9/16-12 x 2 1/2 TORX PLUS® Pan Head	F9028-3618P									
5/8-11 x 1 1/2 TORX PLUS® Pan Head	F9029-4618P									
5/8-11 x 2 TORX PLUS® Pan Head	F9030-5618P									
5/8-11 x 2 1/2 TORX PLUS® Pan Head	F9031-6618P									
M1.6-0.35 x 3mm TORX PLUS® Pan Head	F9032-7618P									
M1.6-0.35 x 4mm TORX PLUS® Pan Head	F9033-8618P									
M1.6-0.35 x 5mm TORX PLUS® Pan Head	F9034-9618P									
M1.6-0.35 x 6mm TORX PLUS® Pan Head	F9035-0718P									
M2-0.4 x 4mm TORX PLUS® Pan Head	F9036-1718P									
M2-0.4 x 4mm TORX PLUS® Flat Head	F9037-618F									
M2-0.4 x 5mm TORX PLUS® Pan Head	F9038-2718P									
M2-0.4 x 6mm TORX PLUS® Pan Head	F9039-3718P									
M2-0.4 x 6mm TORX PLUS® Flat Head	F9040-718F									
M2-0.4 x 8mm TORX PLUS® Pan Head	F9041-4718P									
M2-0.4 x 10mm TORX PLUS® Pan Head	F9072-5718P									
M2-0.4 x 12mm TORX PLUS® Pan Head	F9073-6718P									
M2.5-0.45 x 4mm TORX PLUS® Pan Head	F9074-7718P									
M2.5-0.45 x 5mm TORX PLUS® Pan Head	F9075-8718P									
M2.5-0.45 x 6mm TORX PLUS® Pan Head	F9076-9718P									
M2.5-0.45 x 6mm TORX PLUS® Flat Head	F9077-818F									
M2.5-0.45 x 8mm TORX PLUS® Pan Head	F9078-0818P									
M2.5-0.45 x 8mm TORX PLUS® Flat Head	F9079-918F									
M2.5-0.45 x 10mm TORX PLUS® Pan Head	F9080-1818P									
M2.5-0.45 x 12mm TORX PLUS® Pan Head	F9081-2818P									
M3-0.5 x 6mm TORX PLUS® Pan Head	F9082-008P									
M3-0.5 x 8mm TORX PLUS® Pan Head	F9083-108P									
M3-0.5 x 8mm TORX PLUS® Flat Head	F9084-028F									
M3-0.5 x 10mm TORX PLUS® Pan Head	F9085-3818P									
M3-0.5 x 12mm TORX PLUS® Pan Head	F9086-4818P									
M3.5-0.6 x 6mm TORX PLUS® Pan Head	F9087-208P									
M3.5-0.6 x 8mm TORX PLUS® Pan Head	F9088-308P									
M3.5-0.6 x 10mm TORX PLUS® Pan Head	F9089-5818P									

Torx® is a Registered Trademark of Camcar Textron

Engineered Components

visit our web site for a video tour
www.engcomponents.com



TORX PLUS® TAPTITE® II THREAD-ROLLING FASTENERS Steel-Zinc Plated

Steel, Zinc Plated Taptite Fasteners	ECC Part #	1,000	2,000	3,000	4,000	5,000	10,000	25,000	50,000	100,000
M3.5-0.6 x 12mm TORX PLUS® Pan Head	F9090-408P									
M3.5-0.6 x 16mm TORX PLUS® Pan Head	F9091-6818P									
M3.5-0.6 x 20mm TORX PLUS® Pan Head	F9092-7818P									
M4-0.7 x 8mm TORX PLUS® Pan Head	F9093-8818P									
M4-0.7 x 10mm TORX PLUS® Pan Head	F9094-9818P									
M4-0.7 x 12mm TORX PLUS® Pan Head	F9095-258P									
M4-0.7 x 16mm TORX PLUS® Pan Head	F9096-0918P									
M4-0.7 x 20mm TORX PLUS® Pan Head	F9097-1918P									
M4-0.7 x 25mm TORX PLUS® Pan Head	F9098-2918P									
M4-0.7 x 30mm TORX PLUS® Pan Head	F9099-3918P									
M4.5-0.75 x 10mm TORX PLUS® Pan Head	F9100-4918P									
M4.5-0.75 x 12mm TORX PLUS® Pan Head	F9101-5918P									
M4.5-0.75 x 16mm TORX PLUS® Pan Head	F9102-6918P									
M4.5-0.75 x 20mm TORX PLUS® Pan Head	F9103-7918P									
M4.5-0.75 x 25mm TORX PLUS® Pan Head	F9104-8918P									
M4.5-0.75 x 30mm TORX PLUS® Pan Head	F9105-9918P									
M5-0.8 x 10mm TORX PLUS® Pan Head	F9106-0028P									
M5-0.8 x 12mm TORX PLUS® Pan Head	F9107-448P									
M5-0.8 x 16mm TORX PLUS® Pan Head	F9108-1028P									
M5-0.8 x 20mm TORX PLUS® Pan Head	F9109-2028P									
M5-0.8 x 25mm TORX PLUS® Pan Head	F9110-3028P									
M5-0.8 x 30mm TORX PLUS® Pan Head	F9111-4028P									
M6-1.0 x 12mm TORX PLUS® Pan Head	F9112-5028P									
M6-1.0 x 16mm TORX PLUS® Pan Head	F9113-6028P									
M6-1.0 x 20mm TORX PLUS® Pan Head	F9114-7028P									
M6-1.0 x 25mm TORX PLUS® Pan Head	F9115-8028P									
M6-1.0 x 30mm TORX PLUS® Pan Head	F9116-9028P									
M6-1.0 x 35mm TORX PLUS® Pan Head	F9117-0128P									
M8-1.25 x 16mm TORX PLUS® Pan Head	F9118-1128P									
M8-1.25 x 20mm TORX PLUS® Pan Head	F9119-2128P									
M8-1.25 x 25mm TORX PLUS® Pan Head	F9120-3128P									
M8-1.25 x 30mm TORX PLUS® Pan Head	F9121-4128P									
M8-1.25 x 35mm TORX PLUS® Pan Head	F9122-5128P									
M10-1.5 x 20mm TORX PLUS® Pan Head	F9123-6128P									
M10-1.5 x 25mm TORX PLUS® Pan Head	F9124-7128P									
M10-1.5 x 30mm TORX PLUS® Pan Head	F9125-8128P									
M10-1.5 x 35mm TORX PLUS® Pan Head	F9126-9128P									
M12-1.75 x 25mm TORX PLUS® Pan Head	F9127-0228P									

Torx® is a Registered Trademark of Camcar Textron

Engineered Components

847-841-7000 • Fax 847-841-7007



TORX® PLUS® TAPTITE® II THREAD-ROLLING FASTENERS Steel-Zinc Plated

Steel, Zinc Plated TapTite Fasteners	ECC Part #	1,000	2,000	3,000	4,000	5,000	10,000	25,000	50,000	100,000
M12-1.75 x 30 mm TORX PLUS® Pan Head	F9128-1228P									
M12-1.75 x 35 mm TORX PLUS® Pan Head	F9129-2228P									
M12-1.75 x 40 mm TORX PLUS® Pan Head	F9130-3228P									
M14-2.0 x 25 mm TORX PLUS® Pan Head	F9131-4228P									
M14-2.0 x 30 mm TORX PLUS® Pan Head	F9132-5228P									
M14-2.0 x 35 mm TORX PLUS® Pan Head	F9133-6228P									
M14-2.0 x 40 mm TORX PLUS® Pan Head	F9134-7228P									
M16-2.0 x 25 mm TORX PLUS® Pan Head	F9135-8228P									
M16-2.0 x 30 mm TORX PLUS® Pan Head	F9136-9228P									
M16-2.0 x 35 mm TORX PLUS® Pan Head	F9137-0328P									
M16-2.0 x 40 mm TORX PLUS® Pan Head	F9138-1328P									

Torx® is a Registered Trademark of Camcar Textron

Call For Pricing on Above

Engineered Components

visit our web site for a video tour
www.engcomponents.com



TORX PLUS® PLASTITE® THREAD-FORMING SCREWS

Pan and Flat Head
 Steel-Zinc Plated

Steel, Zinc Plated Plastite Fasteners	ECC Part #	1,000	2,000	3,000	4,000	5,000	10,000	25,000	50,000	100,000
00-51 x 1/8 TORX PLUS® Pan Head	F9139-2328P									
00-51 x 1/8 TORX PLUS® Flat Head	F9140-128F									
00-51 x 1/4 TORX PLUS® Pan Head	F9141-3328P									
00-51 x 5/16 TORX PLUS® Pan Head	F9142-4328P									
0-42 x 3/16 TORX PLUS® Pan Head	F9143-5328P									
0-42 x 1/4 TORX PLUS® Pan Head	F9144-6328P									
0-42 x 5/16 TORX PLUS® Pan Head	F9145-7328P									
0-42 x 3/8 TORX PLUS® Pan Head	F9146-8328P									
1-32 x 3/16 TORX PLUS® Pan Head	F9147-9328P									
1-32 x 1/4 TORX PLUS® Pan Head	F9148-0428P									
1-32 x 1/4 TORX PLUS® Flat Head	F9149-228F									
1-32 x 5/16 TORX PLUS® Pan Head	F9150-1428P									
1-32 x 3/8 TORX PLUS® Pan Head	F9151-2428P									
2-28 x 1/4 TORX PLUS® Pan Head	F9152-3428P									
2-28 x 1/4 TORX PLUS® Flat Head	F9153-328F									
2-28 x 5/16 TORX PLUS® Pan Head	F9154-4428P									
2-28 x 3/8 TORX PLUS® Pan Head	F9155-5428P									
2-28 x 1/2 TORX PLUS® Pan Head	F9156-6428P									
2-28 x 5/8 TORX PLUS® Pan Head	F9157-7428P									
2-28 x 3/4 TORX PLUS® Pan Head	F9158-8428P									
3-24 x 1/4 TORX PLUS® Pan Head	F9159-9428P									
3-24 x 5/16 TORX PLUS® Pan Head	F9160-0528P									
3-24 x 3/8 TORX PLUS® Pan Head	F9161-1528P									
3-24 x 3/8 TORX PLUS® Flat Head	F9162-428F									
3-24 x 1/2 TORX PLUS® Pan Head	F9163-2528P									
3-24 x 5/8 TORX PLUS® Pan Head	F9164-3528P									
3-24 x 3/4 TORX PLUS® Pan Head	F9165-4528P									
4-20 x 1/4 TORX PLUS® Pan Head	F9166-5528P									
4-20 x 5/16 TORX PLUS® Pan Head	F9167-6528P									
4-20 x 3/8 TORX PLUS® Pan Head	F9168-7528P									
4-20 x 3/8 TORX PLUS® Flat Head	F9169-528F									
4-20 x 1/2 TORX PLUS® Pan Head	F9170-9528P									
4-20 x 5/8 TORX PLUS® Pan Head	F9171-0628P									
4-20 x 3/4 TORX PLUS® Pan Head	F9172-1628P									
6-19 x 1/4 TORX PLUS® Pan Head	F9173-2628P									
6-19 x 5/16 TORX PLUS® Pan Head	F9174-3628P									
6-19 x 3/8 TORX PLUS® Pan Head	F9175-4628P									
6-19 x 1/2 TORX PLUS® Pan Head	F9176-5628P									
6-19 x 1/2 TORX PLUS® Flat Head	F9177-628F									
6-19 x 5/8 TORX PLUS® Pan Head	F9178-6628P									
6-19 x 3/4 TORX PLUS® Pan Head	F9179-7628P									
7-18 x 3/8 TORX PLUS® Pan Head	F9180-8628P									

Torx® is a Registered Trademark of Camcar Textron

Engineered Components

847-841-7000 • Fax 847-841-7007



TORX PLUS® PLASTITE® THREAD-FORMING SCREWS

Pan and Flat Head
Steel-Zinc Plated

Steel, Zinc Plated Plastite Fasteners	ECC Part #	1,000	2,000	3,000	4,000	5,000	10,000	25,000	50,000	100,000
7-18 x 1/2 TORX PLUS® Pan Head	F9181-9628P									
7-18 x 5/8 TORX PLUS® Pan Head	F9182-0728P									
7-18 x 3/4 TORX PLUS® Pan Head	F9183-1728P									
8-16 x 3/8 TORX PLUS® Pan Head	F9184-2728P									
8-16 x 1/2 TORX PLUS® Pan Head	F9185-3728P									
8-16 x 1/2 TORX PLUS® Flat Head	F9186-728F									
8-16 x 5/8 TORX PLUS® Pan Head	F9187-4728P									
8-16 x 3/4 TORX PLUS® Pan Head	F9188-5728P									
8-16 x 1 TORX PLUS® Pan Head	F9189-6728P									
9-15 x 1/2 TORX PLUS® Pan Head	F9190-7728P									
9-15 x 1/2 TORX PLUS® Flat Head	F9191-828F									
9-15 x 5/8 TORX PLUS® Pan Head	F9192-8728P									
9-15 x 3/4 TORX PLUS® Pan Head	F9193-9728P									
9-15 x 1 TORX PLUS® Pan Head	F9194-0828P									
10-14 x 1/2 TORX PLUS® Pan Head	F9195-1828P									
10-14 x 1/2 TORX PLUS® Flat Head	F9196-928F									
10-14 x 5/8 TORX PLUS® Pan Head	F9197-2828P									
10-14 x 3/4 TORX PLUS® Pan Head	F9198-3828P									
10-14 x 1 TORX PLUS® Pan Head	F9199-4828P									
12-14 x 1/2 TORX PLUS® Pan Head	F9200-5828P									
12-14 x 5/8 TORX PLUS® Pan Head	F9201-6828P									
12-14 x 3/4 TORX PLUS® Pan Head	F9202-7828P									
12-14 x 1 TORX PLUS® Pan Head	F9203-8828P									
1/4-10 x 1/2 TORX PLUS® Pan Head	F9204-9828P									
1/4-10 x 5/8 TORX PLUS® Pan Head	F9205-0928P									
1/4-10 x 3/4 TORX PLUS® Pan Head	F9206-1928P									
1/4-10 x 1 TORX PLUS® Pan Head	F9207-2928P									
1/4-10 x 1 1/4 TORX PLUS® Pan Head	F9208-3928P									
5/16-9 x 1/2 TORX PLUS® Pan Head	F9209-4928P									
5/16-9 x 5/8 TORX PLUS® Pan Head	F9210-5928P									
5/16-9 x 3/4 TORX PLUS® Pan Head	F9211-6928P									
5/16-9 x 1 TORX PLUS® Pan Head	F9212-7928P									
5/16-9 x 1 1/4 TORX PLUS® Pan Head	F9213-8928P									
M1.12-0.50 x 3 mm TORX PLUS® Pan Head	F9214-9928P									
M1.12-0.50 x 4 mm TORX PLUS® Pan Head	F9215-0038P									
M1.12-0.50 x 5 mm TORX PLUS® Pan Head	F9216-1038P									
M1.12-0.50 x 6 mm TORX PLUS® Pan Head	F9217-2038P									
M1.12-0.50 x 8 mm TORX PLUS® Pan Head	F9218-3038P									
M1.59-0.60 x 3 mm TORX PLUS® Pan Head	F9219-4038P									
M1.59-0.60 x 4 mm TORX PLUS® Pan Head	F9220-5038P									
M1.59-0.60 x 5 mm TORX PLUS® Pan Head	F9221-6038P									

Torx® is a Registered Trademark of Camcar Textron

Engineered Components

visit our web site for a video tour
www.engcomponents.com



TORX PLUS® PLASTITE® THREAD-FORMING SCREWS

Pan and Flat Head
 Steel-Zinc Plated

Steel, Zinc Plated Plastite Fasteners	ECC Part #	1,000	2,000	3,000	4,000	5,000	10,000	25,000	50,000	100,000
M1.59-0.60 x 6mm TORX PLUS® Pan Head	F9222-7038P									
M1.59-0.60 x 8mm TORX PLUS® Pan Head	F9223-8038P									
M1.59-0.60 x 10mm TORX PLUS® Pan Head	F9224-9038P									
M1.91-0.79 x 4mm TORX PLUS® Pan Head	F9225-0138P									
M1.91-0.79 x 5mm TORX PLUS® Pan Head	F9226-1138P									
M1.91-0.79 x 6mm TORX PLUS® Pan Head	F9227-2138P									
M1.91-0.79 x 8mm TORX PLUS® Pan Head	F9228-3138P									
M1.91-0.79 x 10mm TORX PLUS® Pan Head	F9229-4138P									
M2.26-0.91 x 4mm TORX PLUS® Pan Head	F9230-5138P									
M2.26-0.91 x 5mm TORX PLUS® Pan Head	F9231-6138P									
M2.26-0.91 x 6mm TORX PLUS® Pan Head	F9232-7138P									
M2.26-0.91 x 8mm TORX PLUS® Pan Head	F9233-8138P									
M2.26-0.91 x 10mm TORX PLUS® Pan Head	F9234-9138P									
M2.26-0.91 x 12mm TORX PLUS® Pan Head	F9235-0238P									
M2.63-1.06 x 6mm TORX PLUS® Pan Head	F9236-1238P									
M2.63-1.06 x 8mm TORX PLUS® Pan Head	F9237-2238P									
M2.63-1.06 x 10mm TORX PLUS® Pan Head	F9238-3238P									
M2.63-1.06 x 12mm TORX PLUS® Pan Head	F9239-4238P									
M3.12-1.27 x 6mm TORX PLUS® Pan Head	F9240-5238P									
M3.12-1.27 x 8mm TORX PLUS® Pan Head	F9241-6238P									
M3.12-1.27 x 10mm TORX PLUS® Pan Head	F9242-7238P									
M3.12-1.27 x 12mm TORX PLUS® Pan Head	F9243-8238P									
M3.12-1.27 x 16mm TORX PLUS® Pan Head	F9244-9238P									
M3.63-1.34 x 6mm TORX PLUS® Pan Head	F9245-0338P									
M3.63-1.34 x 8mm TORX PLUS® Pan Head	F9246-1338P									
M3.63-1.34 x 10mm TORX PLUS® Pan Head	F9247-2338P									
M3.63-1.34 x 12mm TORX PLUS® Pan Head	F9248-3338P									
M3.63-1.34 x 16mm TORX PLUS® Pan Head	F9249-4338P									
M3.63-1.34 x 20mm TORX PLUS® Pan Head	F9250-5338P									
M4.06-1.41 x 10mm TORX PLUS® Pan Head	F9251-6338P									
M4.06-1.41 x 12mm TORX PLUS® Pan Head	F9252-7338P									
M4.06-1.41 x 16mm TORX PLUS® Pan Head	F9253-8338P									
M4.06-1.41 x 20mm TORX PLUS® Pan Head	F9254-9338P									

Torx® is a Registered Trademark of Camcar Textron

Engineered Components

847-841-7000 • Fax 847-841-7007



TORX PLUS® PLASTITE® THREAD-FORMING SCREWS

Pan and Flat Head
Steel-Zinc Plated

Steel, Zinc Plated Plastite Fasteners	ECC Part #	1,000	2,000	3,000	4,000	5,000	10,000	25,000	50,000	100,000
M4.55-1.59 x 10mm TORX PLUS® Pan Head	F9255-0438P									
M4.55-1.59 x 12mm TORX PLUS® Pan Head	F9256-1438P									
M4.55-1.59 x 16mm TORX PLUS® Pan Head	F9257-2438P									
M4.55-1.59 x 20mm TORX PLUS® Pan Head	F9258-3438P									
M4.55-1.59 x 25mm TORX PLUS® Pan Head	F9259-4438P									
M4.90-1.69 x 10mm TORX PLUS® Pan Head	F9260-5438P									
M4.90-1.69 x 12mm TORX PLUS® Pan Head	F9261-6438P									
M4.90-1.69 x 16mm TORX PLUS® Pan Head	F9262-7438P									
M4.90-1.69 x 20 mm TORX PLUS® Pan Head	F9263-8438P									
M4.90-1.69 x 25 mm TORX PLUS® Pan Head	F9264-9438P									
M5.28-1.81 x 10 mm TORX PLUS® Pan Head	F9265-0538P									
M5.28-1.81 x 12 mm TORX PLUS® Pan Head	F9266-1538P									
M5.28-1.81 x 16 mm TORX PLUS® Pan Head	F9267-2538P									
M5.28-1.81 x 20 mm TORX PLUS® Pan Head	F9268-3538P									
M5.28-1.81 x 25 mm TORX PLUS® Pan Head	F9269-4538P									
M5.28-1.81 x 30 mm TORX PLUS® Pan Head	F9270-5538P									
M5.74-1.81 x 12 mm TORX PLUS® Pan Head	F9271-6538P									
M5.74-1.81 x 16 mm TORX PLUS® Pan Head	F9272-7538P									
M5.74-1.81 x 20 mm TORX PLUS® Pan Head	F9273-8538P									
M5.74-1.81 x 25 mm TORX PLUS® Pan Head	F9274-9538P									
M5.74-1.81 x 30 mm TORX PLUS® Pan Head	F9275-0638P									
M6.81-2.54 x 12 mm TORX PLUS® Pan Head	F9276-1638P									
M6.81-2.54 x 16 mm TORX PLUS® Pan Head	F9277-2638P									
M6.81-2.54 x 20 mm TORX PLUS® Pan Head	F9278-3638P									
M6.81-2.54 x 25 mm TORX PLUS® Pan Head	F9279-4638P									
M6.81-2.54 x 30 mm TORX PLUS® Pan Head	F9280-5638P									
M8.51-2.82 x 12 mm TORX PLUS® Pan Head	F9281-6638P									
M8.51-2.82 x 16 mm TORX PLUS® Pan Head	F9282-7638P									
M8.51-2.82 x 20 mm TORX PLUS® Pan Head	F9283-8638P									
M8.51-2.82 x 25 mm TORX PLUS® Pan Head	F9284-9638P									
M8.51-2.82 x 30 mm TORX PLUS® Pan Head	F9285-0738P									
M8.51-2.82 x 35 mm TORX PLUS® Pan Head	F9286-1738P									

Torx® is a Registered Trademark of Camcar Textron

Engineered Components

visit our web site for a video tour
www.engcomponents.com



TORX PLUS® STAINLESS STEEL PLASTITE® II THREAD-FORMING SCREWS

Pan and Flat Head

Passivated Stainless Steel Plastite® Fasteners	ECC Part #	1,000	2,000	3,000	4,000	5,000	10,000	25,000	50,000	100,000
0-42 x 1/4 TORX PLUS® Pan Head	F9287-719P									
0-42 x 1/4 TORX PLUS® Pan Head	F9288-309F									
0-42 x 3/8 TORX PLUS® Pan Head	F9289-819P									
2-28 x 1/4 TORX PLUS® Pan Head	F9290-919P									
2-28 x 1/4 TORX PLUS® Pan Head	F9291-509F									
2-28 x 3/8 TORX PLUS® Pan Head	F9292-029P									
2-28 x 1/2 TORX PLUS® Pan Head	F9293-129P									
2-28 x 3/4 TORX PLUS® Pan Head	F9294-229P									
4-20 x 1/4 TORX PLUS® Pan Head	F9295-119P									
4-20 x 3/8 TORX PLUS® Pan Head	F9296-219P									
4-20 x 1/2 TORX PLUS® Pan Head	F9297-319P									
4-20 x 3/4 TORX PLUS® Pan Head	F9298-419P									
6-19 x 1/4 TORX PLUS® Pan Head	F9299-429P									
6-19 x 3/8 TORX PLUS® Pan Head	F9300-529P									
6-19 x 1/2 TORX PLUS® Pan Head	F9301-629P									
6-19 x 1/2 TORX PLUS® Pan Head	F9302-609F									
6-19 x 3/4 TORX PLUS® Pan Head	F9303-729P									
8-16 x 3/8 TORX PLUS® Pan Head	F9304-519P									
8-16 x 1/2 TORX PLUS® Pan Head	F9305-619P									
M2.26-0.91 X 6 mm TORX PLUS® Pan Head	F9306-139P									

Torx® is a Registered Trademark of Camcar Textron

847-841-7000 • Fax 847-841-7007



FAB-LOK® FASTENERS

#10-24 Hex Washer Head Machine Screw
Assembled to a Slotted Aluminum Sleeve
and EPDM Sealing Washer

Steel

Part#	Grip	O.A. Length	
EC1-DCF-104A0	.062 - .250	1.373	
EC2-DCF-104A0	.250 - .500	1.612	
EC3-DCF-112A0	.500 - .750	1.807	

Stainless Steel 300 Series

Part#	Grip	O.A. Length	
EC4-DCF-104A5	.062 - .250	1.373	
EC5-DCF-108A5	.250 - .500	1.612	
EC6-DCF-112A5	.500 - .750	1.807	

Engineered Components COMPANY

LAMINATED BUMPERS

**The Last Time You
Will Ever Replace
a Bumper**



**SAVE \$\$\$
ON LABOR
REPLACEMENT
COSTS...**

- Laminated Reinforced Rubber (recycled tires)
- Protects Trailers and Docks
- Heavy Duty Protection
- Durable, Long Lasting
- Available In:
 - > 2⁷/₈" wide
 - > 3⁷/₈" wide
 - > Steel Case Hot Dip Galvanized
 - > Stainless Steel Case
 - > 2 Hole (4 Hole Available)

**Engineered
Components** COMPANY

1100 Davis Road, Elgin, Illinois 60123
Phone: 847.841.7000 • Fax: 847.841.7007

visit our web site for a video tour

www.engcomponents.com

sometimes "RELAXATION" IS A BAD Word

That's what happens after the current wheel nut is tightened.

A common problem encountered by over the road (OTR) tractor trailers is the loosening of the lug nuts on the wheels of both the tractor and the trailer. When the M22 steel is torqued to 500 ft. lbs., 1" of the stud stretches approximately .005 (5 thousandths)...Not Enough to Maintain Clamp Load. It is believed the "relaxation" problem is much greater with aluminum wheels.

The New, Patented M22 Disc Spring Wheel Nut is designed specifically to help solve this "relaxation" problem. This exclusive assembly allows .074 (seventy-four thousandths) and as low as .030 (thirty thousandths) with the Disc Spring starting at 42,000 lbs. factoring in .010 (ten thousandths) "relaxation", you will still have 40,000 lbs. of clamp load. See chart for further detail.

Part # F0899000-0182

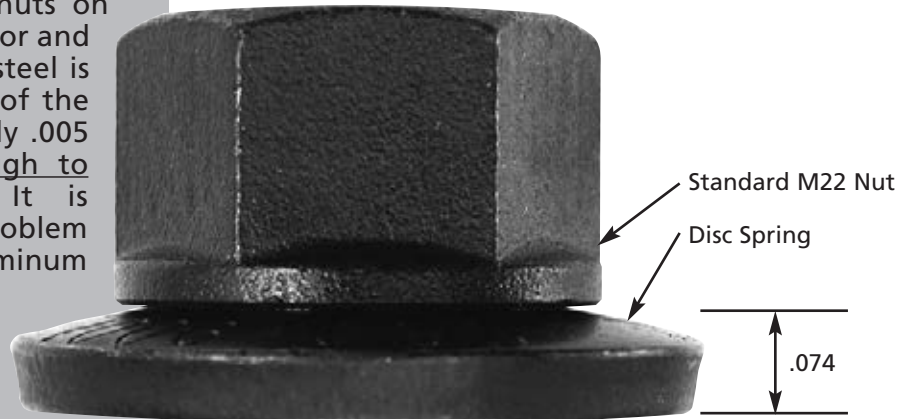

Nut
Conventional M22 Nut
same as being used

Disc Spring
6150 Chrome Vanadium Heat treated phosphate oil and teflon dip. The Disc Spring has a crown, arch, (deflection) of .074

Load Vs. Deflection

Theoretical Vs. Actual

Tightened to flat 500 ft. pounds 42,000 lbs. pressure

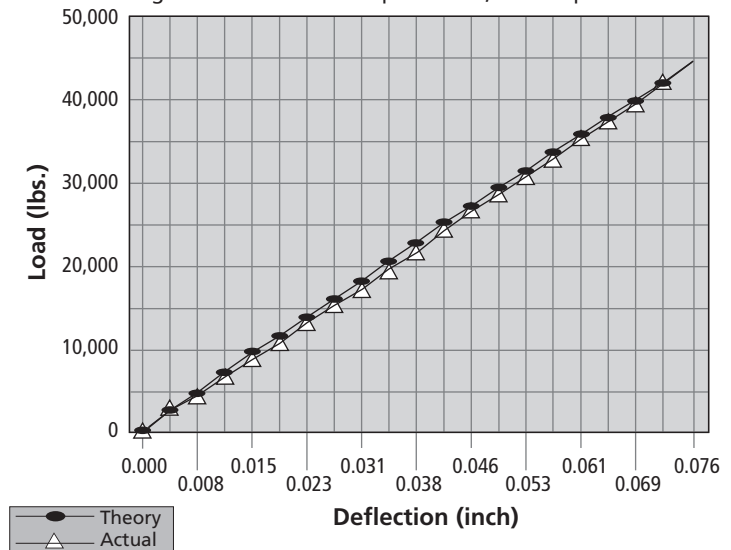

visit our web site for a video tour

www.engcomponents.com

visit our web site for a video tour
www.engcomponents.com

NICNUT®
 Fastening System

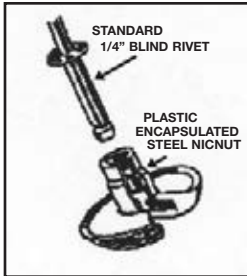

INSTRUCTIONS

1. Drill a 1/4" hole through **all materials**
2. Drill a 13/32" hole through the **FRP ONLY**
3. Install the NICNUT® with the **Required Rivet**

Rivets Sold Separately

GRIP RANGE OF NICNUT® (with RIVET)

RIVET USED (with NICNUT)	GRIP RANGE (with NICNUT)	APPLICATION
SSP 8-6	0.532-0.715	1/2" FRP WITH 'E' Track
SSP 8-8	0.642-0.850	5/8" FRP WITH 'E' TRACK
SSP 8-10	0.755-0.945	3/4" FRP WITH 'E' TRACK

RIVETS AVAILABLE FROM 8-4 to 8-16

GRIP RANGE FROM 1/2" TO 1-1/4"

STANDARD COLOR WHITE

OTHER COLORS AVAILABLE

**Complete Laboratory Test Available Upon Request*

PARTIAL LISTING OF STOCK ITEMS

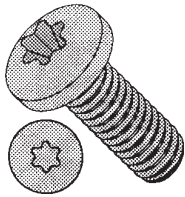

Pan Torx®
Machine Screws

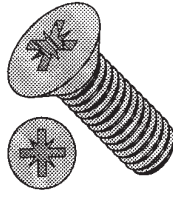

Flat Pozidriv®
Machine Screws

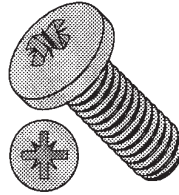

Pan Pozidriv®
Machine Screws

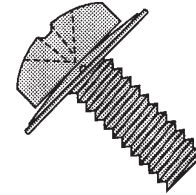

Square Cone® Pan Phil
SEMS

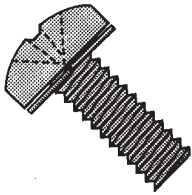

Helical Split Pan Phil
SEMS

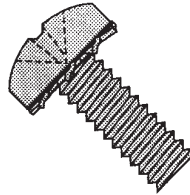

External Pan Phillips
SEMS

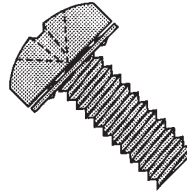

Internal Pan Phillips
SEMS

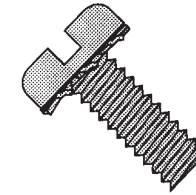

External Pan Slotted
SEMS

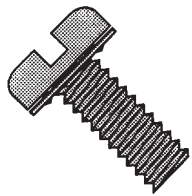

Internal Pan Slotted
SEMS

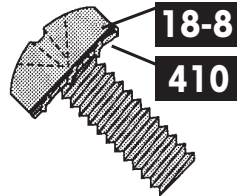

External Pan Phillips
SEMS

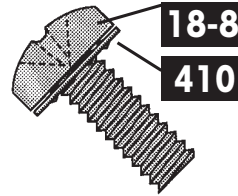

Internal Pan Phillips
SEMS

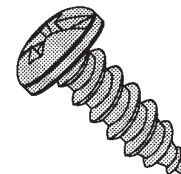

Pan Combo Type A/AB
Tapping Screws

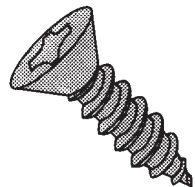

Flat Phillips Type A/AB
Tapping Screws

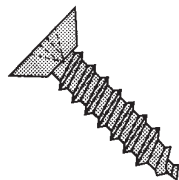

Flat U-Cut Phil Type A/AB
Tapping Screws

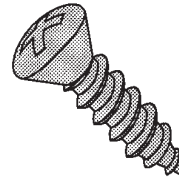

Oval Phillips Type A/AB
Tapping Screws

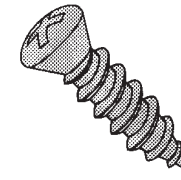

#8 Oval Phil w/#6 Head A
Tapping Screws



Pan Phillips Type A/AB
Tapping Screws

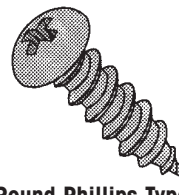

Round Phillips Type A/AB
Tapping Screws

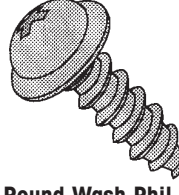

Round Wash Phil Type A
Tapping Screws

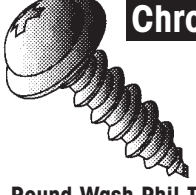

Round Wash Phil Type A
Tapping Screws

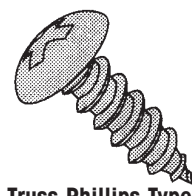

Truss Phillips Type A/AB
Tapping Screws

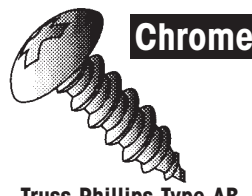

Truss Phillips Type AB
Tapping Screws

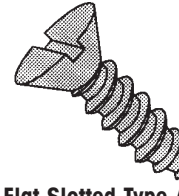

Flat Slotted Type A/AB
Tapping Screws



Flat U-Cut Slot Type A/AB
Tapping Screws

PARTIAL LISTING OF STOCK ITEMS

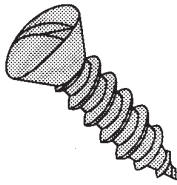

Oval Slotted Type A/AB
Tapping Screws

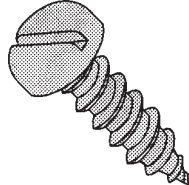

Pan Slotted Type A/AB
Tapping Screws

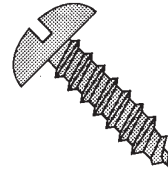

Round Slotted Type A/AB
Tapping Screws

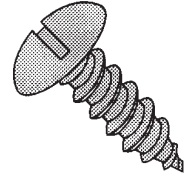

Truss Slotted Type A/AB
Tapping Screws

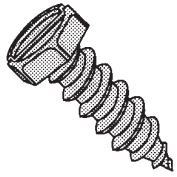

Hex Slotted Type A/AB
Tapping Screws

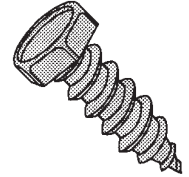

Hex Unslotted Type A/AB
Tapping Screws

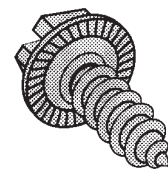

Hex Wash Slot Serrated A/AB
Tapping Screws

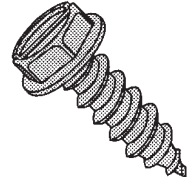

Hex Wash Slot Type A/AB
Tapping Screws

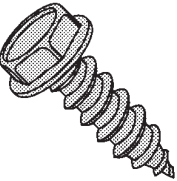

Hex Wash Unslot Type A/AB
Tapping Screws

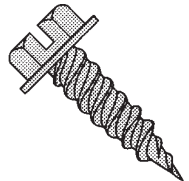

Hex Wash Slot Self Pierce
Tapping Screws



H/W Slot Pierce w/Neo Wash
Tapping Screws

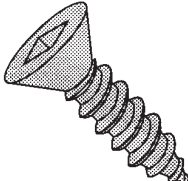

Flat Square Type A
Tapping Screws

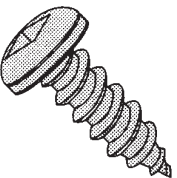

Pan Square Type A/AB
Tapping Screws

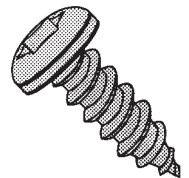

Pan Torx® Type AB
Tapping Screws

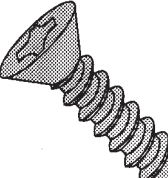

Flat Phillips Type B
Tapping Screws

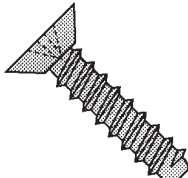

Flat U-Cut Phil Type B
Tapping Screws

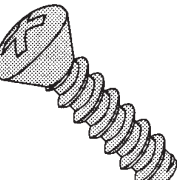

Oval Phillips Type B
Tapping Screws

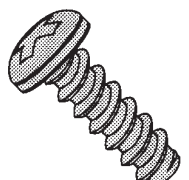

Pan Phillips Type B
Tapping Screws

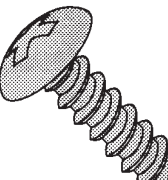

Truss Phillips Type B
Tapping Screws

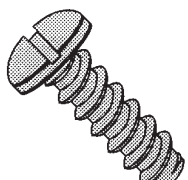

Pan Slotted Type B
Tapping Screws

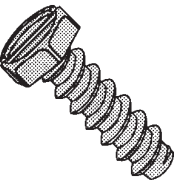

Hex Slotted Type B
Tapping Screws

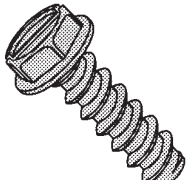

Hex Wash Slotted Type B
Tapping Screws

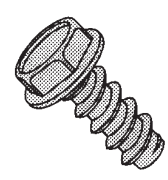

Hex Wash Unslot Type B
Tapping Screws

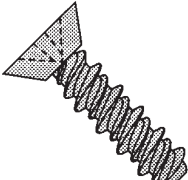

Flat Phillips High-Low
Tapping Screws

PARTIAL LISTING OF STOCK ITEMS

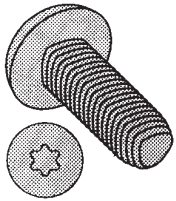

Pan Torx® Taptite® II
Thread Rolling Screws



Hex Wash Slot Taptite® II
Thread Rolling Screws

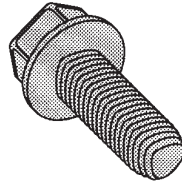

Hex Wash Unslot Taptite® II
Thread Rolling Screws

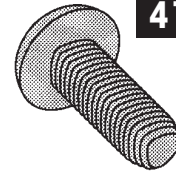

Pan Phillips Taptite® II
Thread Rolling Screws

410

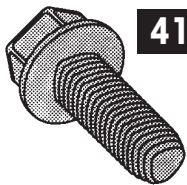

410

Hex Wash Unslot Taptite® II
Thread Rolling Screws

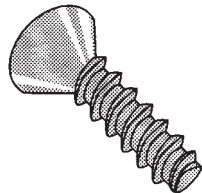

Flat Phillips Plastite®
Thread Rolling Screws

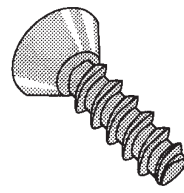

Flat U-Cut Phil Plastite®
Thread Rolling Screws

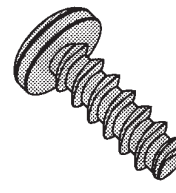

Pan Phillips Plastite®
Thread Rolling Screws

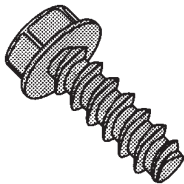

Hex Wash Unslot Plastite®
Thread Rolling Screws

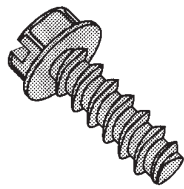

Hex Wash Slot Plastite®
Thread Rolling Screws

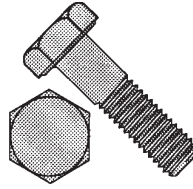

Grade 2
Hex Cap Screws

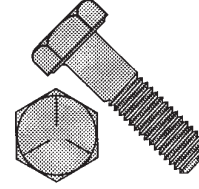

Grade 5
Hex Cap Screws

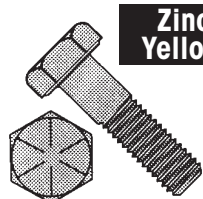

Zinc Yellow

Grade 8
Hex Cap Screws

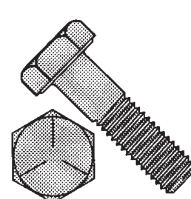

Grade 5
Hex Cap Screws

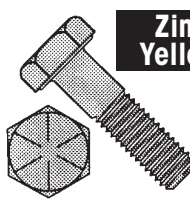

Zinc Yellow

Grade 8
Hex Cap Screws

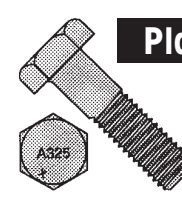

Plain

A325
Structural Bolts

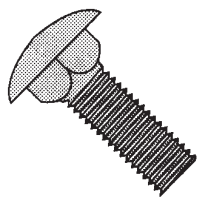

Low Carbon
Carriage Bolts

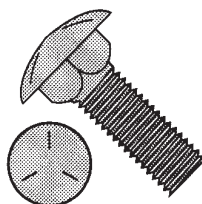

Grade 5
Carriage Bolts

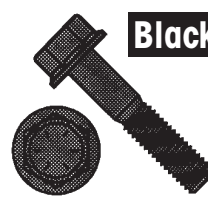

Black Phos

Grade 8
Frame Bolts

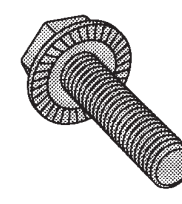

Serrated Hex Washer
Flange Screws

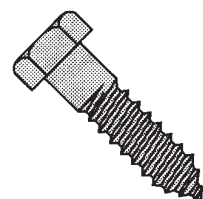

Hex Head
Lag Screws

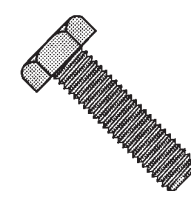

Grade 2
Tap Bolts

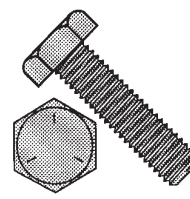

Grade 5
Tap Bolts

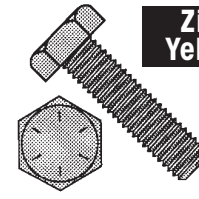

Zinc Yellow

Grade 8
Tap Bolts

visit our web site for a video tour
www.engcomponents.com

PARTIAL LISTING OF STOCK ITEMS

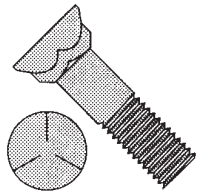

Grade 5
Plow Bolts

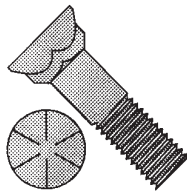

Grade 8
Plow Bolts

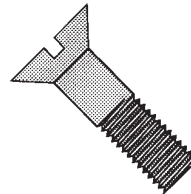

Flat Slotted
Cap Screws

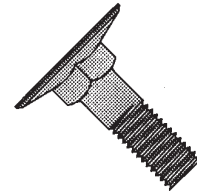

Elevator
Bolts

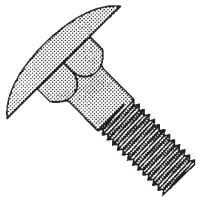

Step
Bolts

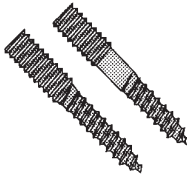

Full & Partial Thread
Hanger Bolts

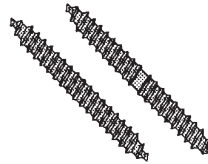

Full Partial Thread
Dowel Screws

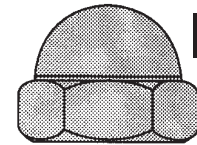

Cap
Nuts

Nickel

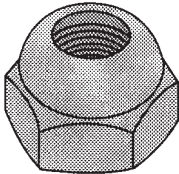

Open End Cap
Nuts

Nickel

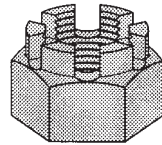

Castle
Nuts

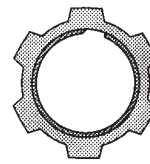

Conduit Lock
Nuts

Zamac

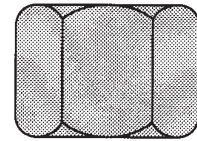

Coupling
Nuts

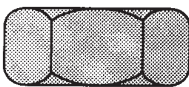

Finished Hex Grade 2
Nuts

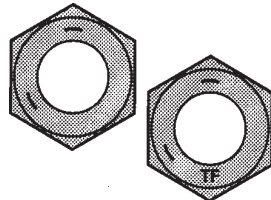

Finished Hex Grade 5
Nuts

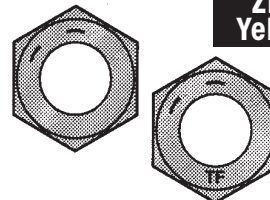

Finished Hex Grade 8
Nuts

Zinc Yellow

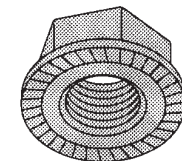

Serrated Flange
Nuts

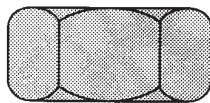

Heavy Hex
Nuts

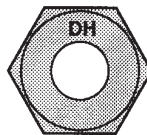

A563 Heavy Hex
Nuts

Plain

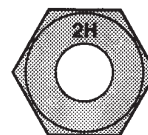

A194 Heavy Hex
Nuts

Plain

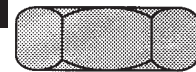

Hex Jam
Nuts

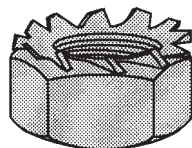

K-Lock
Nuts

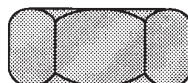

Machine Screw
Nuts

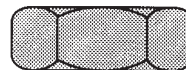

Machine Screw, Small Pattern
Nuts

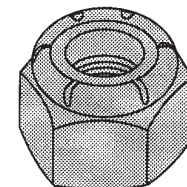

Nylon Insert — NM/NE
Nuts

PARTIAL LISTING OF STOCK ITEMS

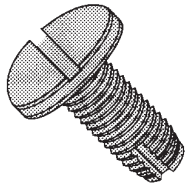

Pan Slotted Type 1
Thread Cutting Screws

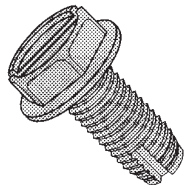

Hex Wash Slot Type 1
Thread Cutting Screws

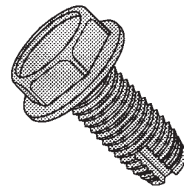

Hex Wash Unslot Type 1
Thread Cutting Screws

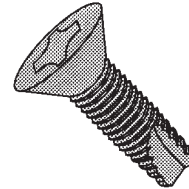

Flat Phillips Type 23
Thread Cutting Screws

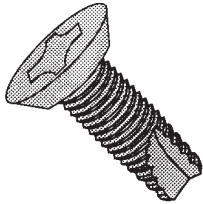

Flat U-Cut Phil Type 23
Thread Cutting Screws

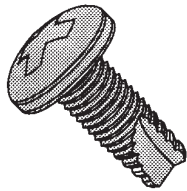

Pan Phillips Type 23
Thread Cutting Screws

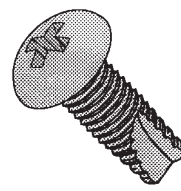

Round Phillips Type 23
Thread Cutting Screws

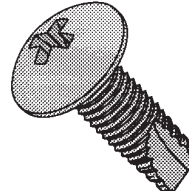

Truss Phillips Type 23
Thread Cutting Screws

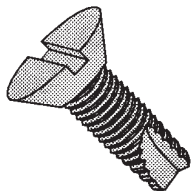

Flat Slotted Type 23
Thread Cutting Screws

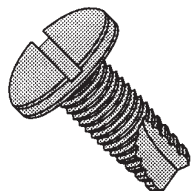

Pan Slotted Type 23
Thread Cutting Screws

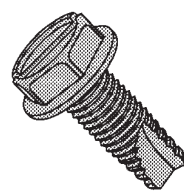

Hex Wash Slot Type 23
Thread Cutting Screws

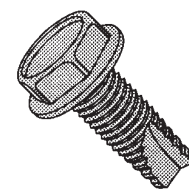

Hex Wash Unslot Type 23
Thread Cutting Screws

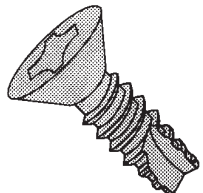

Flat Phillips Type 25
Thread Cutting Screws

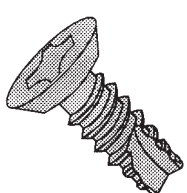

Flat U-Cut Phil Type 25
Thread Cutting Screws

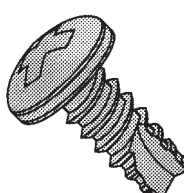

Pan Phillips Type 25
Thread Cutting Screws

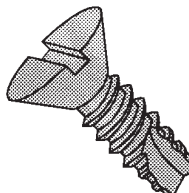

Flat Slotted Type 25
Thread Cutting Screws

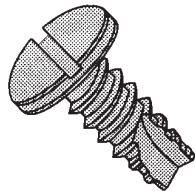

Pan Slotted Type 25
Thread Cutting Screws

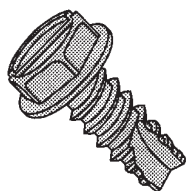

Hex Wash Slot Type 25
Thread Cutting Screws

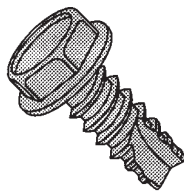

Hex Wash Unslot Type 25
Thread Cutting Screws

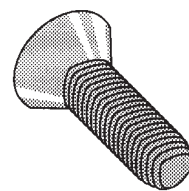

Flat Phillips Taptite® II
Thread Rolling Screws

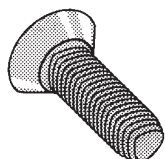

Flat U-Cut Phil Taptite® II
Thread Rolling Screws

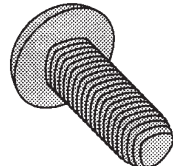

Pan Phillips Taptite® II
Thread Rolling Screws

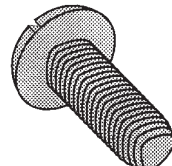

Pan Slotted Taptite® II
Thread Rolling Screws

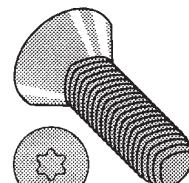

Flat Torx® Taptite® II
Thread Rolling Screws

visit our web site for a video tour
www.engcomponents.com

PARTIAL LISTING OF STOCK ITEMS

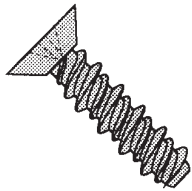

Flat Phil U-Cut High-Low
Tapping Screws

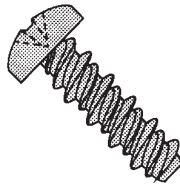

Pan Phillips High-Low
Tapping Screws

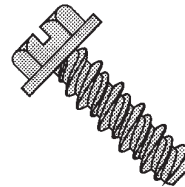

Hex Wash Slot High-Low
Tapping Screws

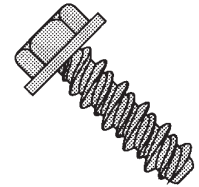

Hex Wash Unslot High-Low
Tapping Screws

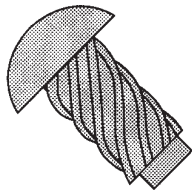

Round Type U
Drive Screws

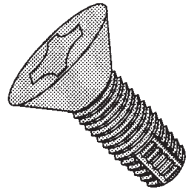

Flat Phillips Type F
Thread Cutting Screws

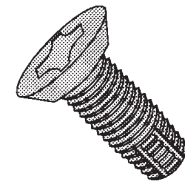

Flat U-Cut Phil Type F
Thread Cutting Screws

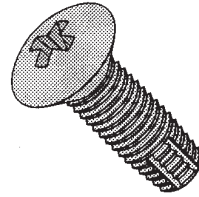

Oval Phillips Type F
Thread Cutting Screws



Pan Phillips Type F
Thread Cutting Screws

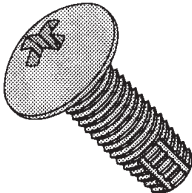

Truss Phillips Type F
Thread Cutting Screws

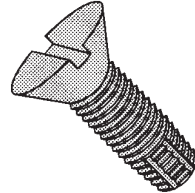

Flat Slotted Type F
Thread Cutting Screws

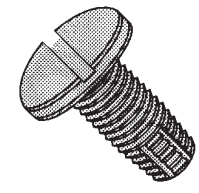

Pan Slotted Type F
Thread Cutting Screws

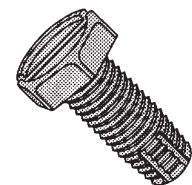

Hex Slotted Type F
Thread Cutting Screws

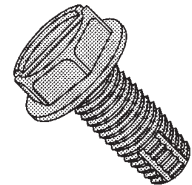

Hex Washer Slot Type F
Thread Cutting Screws

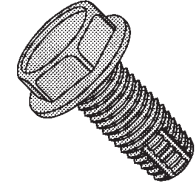

Hex Wash Unslot Type F
Thread Cutting Screws

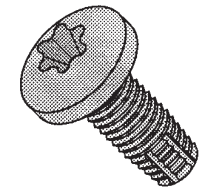

Pan Torx® Type F
Thread Cutting Screws

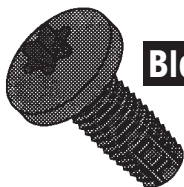

Black Phos

Pan Torx® Type F, Black
Thread Cutting Screws

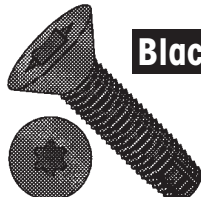

Black Phos

Flat Torx® Floorboard F
Thread Cutting Screws

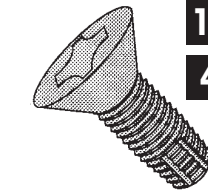

18-8
410

Flat Phillips Type F
Thread Cutting Screws



18-8

Flat U-Cut Phil Type F
Thread Cutting Screws



18-8
410

Pan Phillips Type F
Thread Cutting Screws

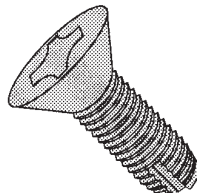

Flat Phillips Type 1
Thread Cutting Screws

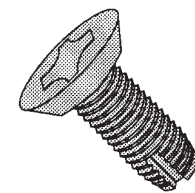

Flat U-Cut Phil Type 1
Thread Cutting Screws

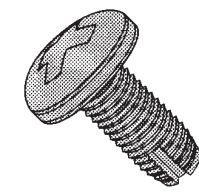

Pan Phillips Type 1
Thread Cutting Screws

PARTIAL LISTING OF STOCK ITEMS

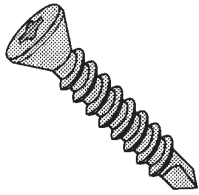

Trim Phillips
Self Drilling Screws

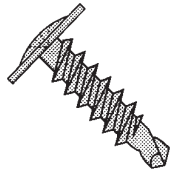

Modified Truss Phillips
Self Drilling Screws



Modified Truss Phil
Self Drilling Screws

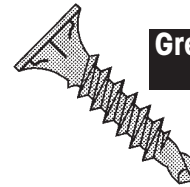

Green Ceramic Finish

Wafer Phil, Drill Point
Self Drilling Screws



Green Ceramic Finish

Wafer Phil, H-L, Spade Pt
Self Drilling Screws

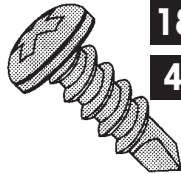

18-8
410

Pan Phillips
Self Drilling Screws

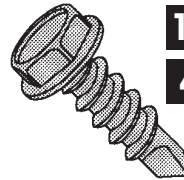

18-8
410

Hex Washer Unslotted
Self Drilling Screws

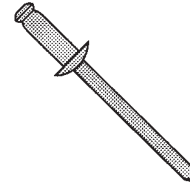

Dome Head (various materials)
Blind Rivets



Aluminum/Steel

Countersunk "U-Fix"
Blind Rivets



Aluminum/Steel

Large Flange "U-Fix"
Blind Rivets



Aluminum/Steel

Low Profile "U-Fix"
Blind Rivets

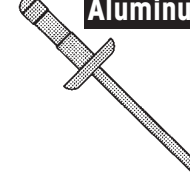

Aluminum/Steel

Dome "U-Fix"
Blind Rivets



Steel/Steel

Countersunk "Steel-Fix"
Blind Rivets



Steel/Steel

Large Flange "Steel-Fix"
Blind Rivets



Steel/Steel

Dome "Steel-Fix"
Blind Rivets

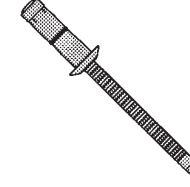

Dome, All Alum Orlock®
Blind Rivets

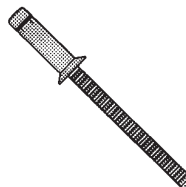

Cntrsnk, All Alum Orlock®
Blind Rivets



Zinc Yellow

Dome, All Steel Orlock®
Blind Rivets



Zinc Yellow

Cntrsnk, All Steel Orlock®
Blind Rivets

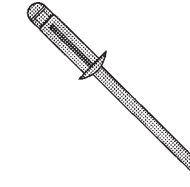

Dome "3-Star" All Alum
Bulbing Type Rivets

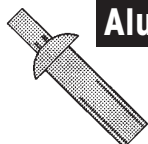

Aluminum

Universal Head
Drive Pin Rivets



Aluminum

Brazier Head
Drive Pin Rivets



Aluminum

Liner Head
Drive Pin Rivets

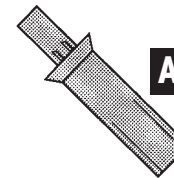

Aluminum

Countersunk Head
Drive Pin Rivets

Engineered Components

visit our web site for a video tour
www.engcomponents.com

PARTIAL LISTING OF STOCK ITEMS



Aluminum

Brazier Head, Masonry Drive Pin Rivets

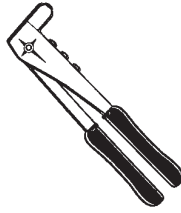

Cast Aluminum Rivet Hand Guns

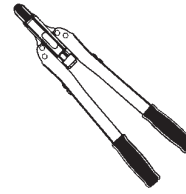

Steel Heavy Duty Rivet Hand Guns

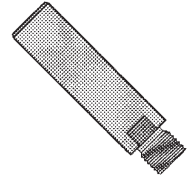

Replacement Shaft For Rivet Hand Guns

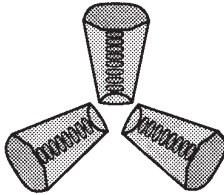

Replacement Jaws For Rivet Hand Guns

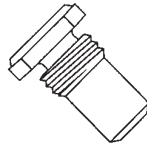

Replacement Nose Piece For Rivet Hand Guns

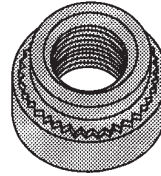

**Steel Zinc
303 Series SS**

Nut Self Clinchings

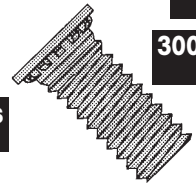

**Steel Zinc
300 Series SS**

Flush Head Stud Self Clinchings

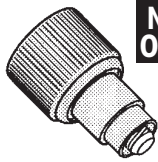

Natural Or Black

Flare-In Panel Fasteners

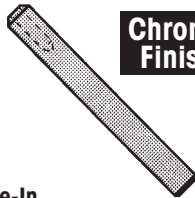

Chrome Finish

Flare-In Panel Tools



Natural Or Black

Press-In Panel Fasteners

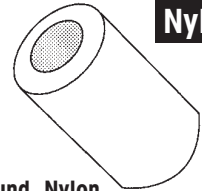

Nylon

Round, Nylon Spacers

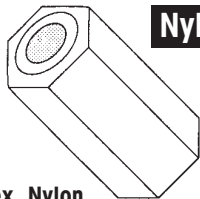

Nylon

Hex, Nylon Spacers

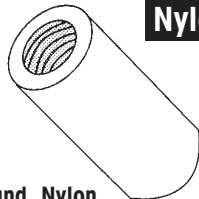

Nylon

Round, Nylon Standoffs

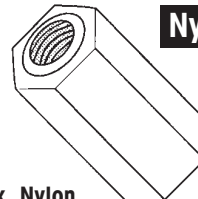

Nylon

Hex, Nylon Standoffs

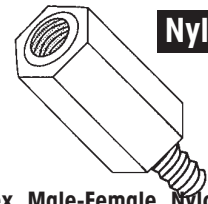

Nylon

Hex, Male-Female, Nylon Standoffs



Aluminum

Round, Alum Spacers



Aluminum

Round, Alum Standoffs

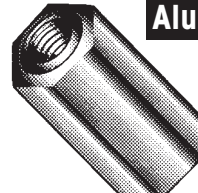

Aluminum

Hex, Alum Standoffs



Aluminum

Round, Male-Female, Alum Standoffs

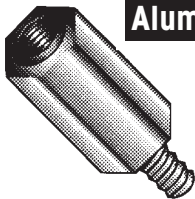

Aluminum

Hex, Male-Female, Alum Standoffs

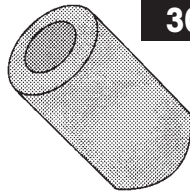

303 SS

Round, Stainless Spacers

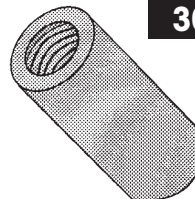

303 SS



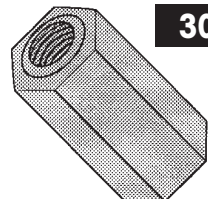



















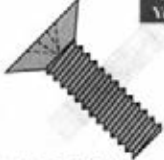

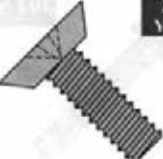



Round, Stainless Standoffs



303 SS

Hex, Stainless Standoffs































PARTIAL LISTING OF STOCK ITEMS

 <p>Black Ox</p> <p>Flat Phillips Type AB Tapping Screws</p>	 <p>Black Ox</p> <p>Flat Undercut Phil Type AB Tapping Screws</p>	 <p>Black Ox</p> <p>Truss Phillips Type A Tapping Screws</p>	 <p>Black Ox</p> <p>Pan Phillips Type A/AB Tapping Screws</p>	 <p>Black Ox</p> <p>Round Washer Phillips A Tapping Screws</p>
 <p>Black Ox</p> <p>Pan Phillips Type F Thread Cutting Screws</p>	 <p>Black Ox</p> <p>Hex Washer Unslotted Self Drilling Screws</p>	 <p>Black Ox</p> <p>Hex Machine Screw Nuts</p>	 <p>Black Ox</p> <p>Acorn Cap Nuts</p>	 <p>Black Ox</p> <p>Tooth Lock Washers</p>
 <p>Black Ox</p> <p>Regular Split Lock Washers</p>	 <p>Black Ox</p> <p>Machine Screw Washers</p>	 <p>Black Ox</p> <p>Countersunk Finishing Washers</p>	 <p>Zinc Yellow</p> <p>Flat 100° Phillips Machine Screws</p>	 <p>Zinc Yellow</p> <p>Flat 82° Phillips Machine Screws</p>
 <p>Zinc Yellow</p> <p>Flat Undercut Phillips Machine Screws</p>	 <p>Zinc Yellow</p> <p>Pan Phillips Machine Screws</p>	 <p>Zinc Yellow</p> <p>Flat Slotted Machine Screws</p>	 <p>Zinc Yellow</p> <p>Pan Slotted Machine Screws</p>	 <p>Zinc Yellow</p> <p>Hex Machine Screw Nuts</p>
 <p>Zinc Yellow</p> <p>External Tooth Lock Washers</p>	 <p>Zinc Yellow</p> <p>Internal Tooth Lock Washers</p>	 <p>Zinc Yellow</p> <p>Countersunk Ext Tooth Lock Washers</p>	 <p>Zinc Yellow</p> <p>Combination Ext-Int Tooth Lock Washers</p>	 <p>Zinc Yellow</p> <p>Regular Split Lock Washers</p>
 <p>Zinc Yellow</p> <p>Machine Screw Washers</p>	 <p>Hot Dip Galv</p> <p>Carriage Bolts</p>	 <p>Hot Dip Galv</p> <p>Hex Lag Screws</p>	 <p>Hot Dip Galv</p> <p>Hex Machine Bolts</p>	 <p>Hot Dip Galv</p> <p>Finished Hex Nuts</p>

























Engineered Components

visit our web site for a video tour
www.engcomponents.com

PARTIAL LISTING OF STOCK ITEMS

				
Pozidriv®-Alternative Insert Bits	Pozidriv®-Alternative Power Bits	Square Recess Insert Bits	Square Recess Power Bits	Magnetic Hex Insert Bit Holders
	 Blue Polymer	 Blue Polymer	 304 SS Zinc	
Magnetic Power Nutsetters	Flat Phillips Concrete Screws	Hex Washer Slotted Concrete Screws	Hex Wedge Anchors	Hex Sleeve Anchors
				
Flat Sleeve Anchors	Acorn Sleeve Anchors	Round Sleeve Anchors	Threshold Flat Sleeve Anchors	Tie-Wire Sleeve Anchors
	 304 SS	 304 SS	 304 SS	 304 SS
Rod Hanger Sleeve Anchors	Hex Sleeve Anchors	Flat Sleeve Anchors	Acorn Sleeve Anchors	Round Sleeve Anchors
 303/304 SS Zinc		 304 SS Zamac		
Drop-In Anchors	Drop-In Anchor Setting Tools	Mushroom Head Hammer Drive Anchors	Flat Split Drive Anchors	Round Split Drive Anchors
	 Nylon	 Nylon	 Nylon	 Nylon
Tie-Wire Split Drive Anchors	Mushroom Hammer Drive Anchors	Flat Hammer Drive Anchors	Round Hammer Drive Anchors	Nylon Poly-Toggles

PARTIAL LISTING OF STOCK ITEMS

				
Flat Slotted Machine Screws	Flat Undercut Slotted Machine Screws	Fillister Slotted Machine Screws	Oval Slotted Machine Screws	Pan Slotted Machine Screws
				
Round Slotted Machine Screws	Truss Slotted Machine Screws	Hex Slotted Machine Screws	Hex Unslotted Machine Screws	Hex Washer Slotted Machine Screws
				
Hex Washer Unslotted Machine Screws	Flat Torx[®] Machine Screws	Flat Undercut Torx[®] Machine Screws	Pan Torx[®] Machine Screws	Flat Pozidriv[®]-Alternative Machine Screws
				
Pan Pozidriv[®]-Alternative Machine Screws	Square Cone[®] Pan Phil SEMS	Helical Split Pan Phil SEMS	External Pan Phillips SEMS	Internal Pan Phillips SEMS
				
External Pan Slotted SEMS	Internal Pan Slotted SEMS	External Pan Phillips SEMS	Internal Pan Phillips SEMS	Pan Combo Type A/AB Tapping Screws
				
Flat Phillips Type A/AB Tapping Screws	Flat U-Cut Phil Type A/AB Tapping Screws	Oval Phillips Type A/AB Tapping Screws	#8 Oval Phil w/#6 Head A Tapping Screws	Pan Phillips Type A/AB Tapping Screws









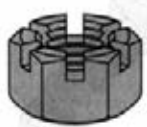
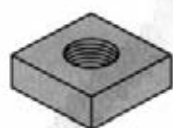

 18-8 Flat 100° Slotted Machine Screws	 18-8 Fillister Slotted Machine Screws	 18-8 Oval Slotted Machine Screws	 18-8 Pan Slotted Machine Screws	 18-8 Round Slotted Machine Screws
 18-8 Truss Slotted Machine Screws	 18-8 Hex Slotted Machine Screws	 18-8 Hex Unslotted Machine Screws	 18-8 Hex Washer Slotted Machine Screws	 18-8 Hex Washer Unslotted Machine Screws
 18-8 410 Int Tooth Pan Phillips SEMS	 18-8 410 Ext Tooth Pan Phillips SEMS	 18-8 Flat Phillips Type A/AB Tapping Screws	 18-8 Flat U-Cut Phil Type A/AB Tapping Screws	 18-8 Oval Phillips Type A/AB Tapping Screws
 18-8 Oval U-Cut Phil Type AB Tapping Screws	 18-8 Pan Phillips Type A/AB Tapping Screws	 18-8 Truss Phillips Type A/AB Tapping Screws	 18-8 Pan Slotted Type A/AB Tapping Screws	 18-8 Hex Washer Slot Type A/AB Tapping Screws
 18-8 Pan Phillips Type B Tapping Screws	 410 Flat Phillips High-Low Tapping Screws	 410 Pan Phillips High-Low Tapping Screws	 410 Hex Wash Unslot High-Low Tapping Screws	 18-8 410 Flat Phillips Type F Thread Cutting Screws
 18-8 Flat U-Cut Phil Type F Thread Cutting Screws	 18-8 410 Pan Phillips Type F Thread Cutting Screws	 410 Pan Phillips Taptite® II Thread Rolling Screws	 410 Hex Wash Unslot Taptite® II Thread Cutting Screws	 18-8 Hex Head Cap Screws

 <p>18-8</p> <p>Nylon Insert Stop Nuts</p>	 <p>18-8</p> <p>Cold Forged Wing Nuts</p>	 <p>18-8 316</p> <p>Standard Flat Washers</p>	 <p>18-8</p> <p>Fender Washers</p>	 <p>18-8</p> <p>Machine Screw Washers</p>
 <p>316 18-8</p> <p>Medium Split Lock Washers</p>	 <p>410</p> <p>External Tooth Lock Washers</p>	 <p>410</p> <p>Internal Tooth Lock Washers</p>	 <p>18-8</p> <p>Bugle Head Deck Screws</p>	 <p>18-8 410</p> <p>Pan Phillips Self Drilling Screws</p>
 <p>18-8 410</p> <p>Hex Washer Unslotted Self Drilling Screws</p>	 <p>303 SS</p> <p>Self Clinch Clinching Nuts</p>	 <p>300 Series SS</p> <p>Flush Head Clinching Studs</p>	 <p>305 SS</p> <p>Dome Head Blind Rivets</p>	 <p>305 SS</p> <p>Large Flange Blind Rivets</p>
 <p>15-7 SS</p> <p>Type E & SE Retaining Rings</p>	 <p>15-7 SS</p> <p>Internal Type HO Retaining Rings</p>	 <p>15-7 SS</p> <p>External Type SH Retaining Rings</p>	 <p>304 SS</p> <p>Hex Head Wedge Anchors</p>	 <p>304 SS</p> <p>Hex Sleeve Anchors</p>
 <p>304 SS</p> <p>Flat Sleeve Anchors</p>	 <p>304 SS</p> <p>Acorn Nut Sleeve Anchors</p>	 <p>304 SS</p> <p>Round Head Sleeve Anchors</p>	 <p>303/304 SS</p> <p>Drop-In Anchors</p>	 <p>304 SS</p> <p>Mushroom Head Hammer Drive Anchors</p>
 <p>Pan Combination Machine Screws</p>	 <p>Round Combination Machine Screws</p>	 <p>Truss Combination Machine Screws</p>	 <p>Binding Phillips Machine Screws</p>	 <p>Flat Phillips Machine Screws</p>

Engineered Components

visit our web site for a video tour
www.engcomponents.com

PARTIAL LISTING OF STOCK ITEMS

 Nylon Insert Heavy Hex-NU Nuts	 Nylon Insert Heavy Hex-NTU Nuts	 Nylon Insert Grade 8-N1610 Nuts	 Slotted Nuts	 Panel Nuts
 Square Machine Nuts	 Regular Square Nuts	 Spring, Flat Type Nuts	 Spring, U-Type Nuts	 Spring, J-Type Nuts
 Grade C Lock Nuts	 Grade GT Flange Nuts	 Tee Nuts	 Two-Way Reversible Lock Nuts	 Wing, Cold Forged Nuts
 Wing, Stamped Nuts	 Wing, Washer Based Nuts	 Countersunk Finishing Washers	 External Tooth Lock Washers	 Internal Tooth Lock Washers
 Ext-Int Combination Lock Washers	 Countersunk External Lock Washers	 Split Lock Washers	 Machine Screw Washers	 Fender Washers
 S.A.E./U.S.S. Washers	 S.A.E. & U.S.S. Extra Thick Washers	 F436 Structural Washers	 Dock Washers	 Beveled Washers

 <p>Steel Zinc 303 Series SS</p> <p>Nuts Self Clinching</p>	 <p>Steel Zinc 300 Series SS</p> <p>Flush Head Studs Self Clinching</p>	 <p>Natural Or Black</p> <p>Flare-In Panel Fasteners</p>	 <p>Chrome Finish</p> <p>Flare-In Panel Tools</p>	 <p>Natural Or Black</p> <p>Press-In Panel Fasteners</p>
 <p>Nylon</p> <p>Round, Nylon Spacers</p>	 <p>Nylon</p> <p>Hex, Nylon Spacers</p>	 <p>Nylon</p> <p>Round, Nylon Standoffs</p>	 <p>Nylon</p> <p>Hex, Nylon Standoffs</p>	 <p>Nylon</p> <p>Hex, Male-Female, Nylon Standoffs</p>
 <p>Aluminum</p> <p>Round Spacers</p>	 <p>Aluminum</p> <p>Round Standoffs</p>	 <p>Aluminum</p> <p>Hex Standoffs</p>	 <p>Aluminum</p> <p>Round, Male-Female Standoffs</p>	 <p>Aluminum</p> <p>Hex, Male-Female Standoffs</p>
 <p>303 SS</p> <p>Round Spacers</p>	 <p>303 SS</p> <p>Round Standoffs</p>	 <p>303 SS</p> <p>Hex Standoffs</p>	 <p>303 SS</p> <p>Round, Male-Female Standoffs</p>	 <p>303 SS</p> <p>Hex, Male-Female Standoffs</p>
 <p>15-7 SS</p> <p>Internal Type HO Retaining Rings</p>	 <p>15-7 SS</p> <p>External Type SH Retaining Rings</p>	 <p>15-7 SS</p> <p>Type E & SE Retaining Rings</p>	 <p>Phos Coated</p> <p>Type E & SE Retaining Rings</p>	 <p>Phos Coated</p> <p>Internal Type HO Retaining Rings</p>
 <p>Phos Coated</p> <p>External Type SH Retaining Rings</p>	 <p>Assortment Kits Retaining Rings</p>	 <p>Replacement Tip Pliers Kits</p>	 <p>Socket Head Cap Screws</p>	 <p>18-8</p> <p>Socket Head Cap Screws</p>

Engineered Components

visit our web site for a video tour
www.engcomponents.com

PARTIAL LISTING OF STOCK ITEMS

<p>Brass</p>  <p>Steel</p>  <p>Short & Long Arm Hex Wrench Sets</p>  <p>X-Trac Tools</p>  <p>X-Trac Broachs</p> 	<p>Socket Pipe Plugs</p>  <p>X-Trac Sleeves</p>  <p>Socket Head Cap Screws</p>  <p>Socket Head Cap Screws</p>  <p>Flat Head Cap Screws</p>  <p>Button Head Cap Screws</p>	<p>Metric</p>  <p>Cup Point Socket Set Screws</p>  <p>Short Arm Hex Wrenches</p>  <p>Short Arm Hex Wrench Sets</p>  <p>Socket Screw Guides</p>  <p>Cotter Pins</p>	<p>Black & Oiled</p>  <p>Spring Pins</p>  <p>Plain Thumb Screws</p>  <p>Shoulder Thumb Screws</p>  <p>Stamped Wing Screws</p>  <p>Flat Phillips Wood Screws</p>	<p>Oval Phillips Wood Screws</p>  <p>Round Phillips Wood Screws</p>  <p>Flat Slotted Wood Screws</p>  <p>Oval Slotted Wood Screws</p>  <p>Round Slotted Wood Screws</p> 	<p>Plain</p>  <p>Projections Under Head Weld Screws</p>  <p>Projections Top Of Head Weld Screws</p>  <p>Single Projection, Offset Weld Nuts</p>  <p>Multi Projection, Center Weld Nuts</p>  <p>No Projection, Offset Weld Nuts</p>
---	---	--	---	---	--

 <p>Hot Dip Galv</p> <p>U.S.S. Flat Washers</p>	 <p>Hot Dip Galv</p> <p>Regular Split Lock Washers</p>	 <p>Hot Dip Galv</p> <p>Dock Washers</p>	 <p>Phillips Insert Bits</p>	 <p>Phillips Power Bits</p>
 <p>Reduced Phillips Insert Bits</p>	 <p>Slotted Insert Bits</p>	 <p>Slotted Power Bits</p>	 <p>Torx-Alternative Insert Bits</p>	 <p>Torx-Alternative Power Bits</p>
 <p>Nylon Zamac</p> <p>One Step Wallboard Anchors</p>	 <p>Standard Hollow Wall Anchors-270</p>	 <p>Drive-style Hollow Wall Anchors-270</p>	 <p>Hollow Wall Anchor Installation Tools-270</p>	 <p>Zamac</p> <p>Lag Screw Shields-270</p>
 <p>Lead</p> <p>Lead Wood Screw Anchors</p>	 <p>Plastic</p> <p>Conical Wall Anchors</p>	 <p>Plastic</p> <p>Fluted Plastic Wall Anchors</p>	 <p>Plastic</p> <p>Tapered & Ribbed Wall Anchors</p>	 <p>Zamac/Lead</p> <p>Machine Screw Anchors</p>
 <p>Round Phillips Type A/AB Tapping Screws</p>	 <p>Round Wash Phil Type A Tapping Screws</p>	 <p>Chrome</p> <p>Round Wash Phil Type A Tapping Screws</p>	 <p>Truss Phillips Type A/AB Tapping Screws</p>	 <p>Chrome</p> <p>Truss Phillips Type AB Tapping Screws</p>
 <p>Flat Slotted Type A/AB Tapping Screws</p>	 <p>Flat U-Cut Slot Type A/AB Tapping Screws</p>	 <p>Oval Slotted Type A/AB Tapping Screws</p>	 <p>Pan Slotted Type A/AB Tapping Screws</p>	 <p>Round Slotted Type A/AB Tapping Screws</p>











Engineered Components

visit our web site for a video tour
www.engcomponents.com

PARTIAL LISTING OF STOCK ITEMS

 <p>316</p> <p>Hex Head Cap Screws</p>	 <p>18-8</p> <p>Round Head Carriage Bolts</p>	 <p>18-8</p> <p>Hex Head Lag Screws</p>	 <p>18-8</p> <p>Full & Partial Thread Hanger Bolts</p>	 <p>18-8 316</p> <p>Finished Hex Nuts</p>
 <p>18-8</p> <p>Heavy Hex Nuts</p>	 <p>18-8</p> <p>Hex Jam Nuts</p>	 <p>18-8</p> <p>Hex Machine Screw Nuts</p>	 <p>18-8</p> <p>Cap Nuts</p>	 <p>18-8</p> <p>External Tooth K-Lock Nuts</p>
 <p>Flat Undercut Phillips Machine Screws</p>	 <p>Flat 100° Phillips Machine Screws</p>	 <p>Fillister Phillips Machine Screws</p>	 <p>Oval Phillips Machine Screws</p>	 <p>Oval Undercut Phillips Machine Screws</p>
 <p>Pan Phillips Machine Screws</p>	 <p>Round Phillips Machine Screws</p>	 <p>Truss Phillips Machine Screws</p>	 <p>Hex Washer Phillips Machine Screws</p>	 <p>Binding Undercut Slotted Machine Screws</p>
 <p>Black Phos</p> <p>Drill & Sharp Point, Fine Drywall Screws</p>	 <p>Black Phos</p> <p>Sharp Point, Coarse Drywall Screws</p>	 <p>Black Phos</p> <p>Sharp Point, High-Low Drywall Screws</p>	 <p>Black Phos</p> <p>Pan Phillips, Fine Drywall Screws</p>	 <p>Black Phos</p> <p>Bugle Phillips Particle Board Screws</p>
 <p>Black Phos</p> <p>Trim Phillips, Fine Drywall Screws</p>	 <p>Black Phos</p> <p>Square Phillips, Fine Drywall Screws</p>	 <p>Dacrotized</p> <p>Bugle Phillips Deck Screws</p>	 <p>Dacrotized</p> <p>Square Phillips Deck Screws</p>	 <p>18-8</p> <p>Bugle Phillips Deck Screws</p>

PARTIAL LISTING OF STOCK ITEMS

 <p>Low Head Socket Cap Screws</p>	 <p>Flat Head Cap Screws</p>	 <p>Button Head Cap Screws</p>	 <p>Socket Shoulder Screws</p>	 <p>Cup Point Socket Set Screws</p>
 <p>Cone Point Socket Set Screws</p>	 <p>Half Dog Point Socket Set Screws</p>	 <p>Flat Point Socket Set Screws</p>	 <p>Oval Point Socket Set Screws</p>	 <p>Dowel Pins Bright or Ebony Finish</p>
 <p>No Projection, Center Weld Nuts Plain</p>	 <p>Flat 100° Phillips Machine Screws Black Ox over 18-8 SS</p>	 <p>Flat 82° Phillips Machine Screws Black Ox over 18-8 SS</p>	 <p>Flat Undercut Phillips Machine Screws Black Ox over 18-8 SS</p>	 <p>Pan Phillips Machine Screws Black Ox over 18-8 SS</p>
 <p>Flat 100° Phillips Machine Screws Black Ox</p>	 <p>Flat 82° Phillips Machine Screws Black Ox</p>	 <p>Flat Undercut Phillips Machine Screws Black Ox</p>	 <p>Pan Phillips Machine Screws Black Ox</p>	 <p>Hex Washer Slotted Machine Screws Black Ox</p>

ENGINEERED COMPONENTS CO.

1100 Davis Road • Elgin, IL 60123
 Phone 847-841-7000 • Fax 847-841-7007
 Web Site: www.engcomponents.com

TIGHTENING TORQUE GUIDE (GUIDELINE ONLY)*

SAE GRADE 2 Coarse Thread

SIZE	CLAMP LOAD	PLAIN	PLATED
1/4 - 20 (.250)	1,313	66 in. lbs.	49 in. lbs.
5/16 - 18 (.3125)	2,175	11 ft. lbs.	8 ft. lbs.
3/8 - 16 (.375)	3,188	20 ft. lbs.	15 ft. lbs.
7/16 - 14 (.4375)	4,388	32 ft. lbs.	24 ft. lbs.
1/2 - 13 (.500)	5,850	49 ft. lbs.	37 ft. lbs.
9/16 - 12 (.5625)	7,500	70 ft. lbs.	53 ft. lbs.
5/8 - 11 (.625)	9,300	97 ft. lbs.	73 ft. lbs.
3/4 - 10 (.750)	13,800	173 ft. lbs.	129 ft. lbs.
7/8 - 9 (.875)	11,400	166 ft. lbs.	125 ft. lbs.
1 - 8 (1.000)	15,000	250 ft. lbs.	188 ft. lbs.
1-1/8 - 7 (1.125)	18,900	354 ft. lbs.	266 ft. lbs.
1-1/4 - 7 (1.250)	24,000	500 ft. lbs.	375 ft. lbs.
1-3/8 - 6 (1.375)	28,575	655 ft. lbs.	491 ft. lbs.
1-1/2 - 6 (1.500)	34,800	870 ft. lbs.	652 ft. lbs.

SAE GRADE 2 Fine Thread

SIZE	CLAMP LOAD	PLAIN	PLATED
1/4 - 28 (.250)	1,500	75 in. lbs.	56 in. lbs.
5/16 - 24 (.3125)	2,400	13 ft. lbs.	9 ft. lbs.
3/8 - 24 (.375)	3,600	23 ft. lbs.	17 ft. lbs.
7/16 - 20 (.4375)	4,913	36 ft. lbs.	27 ft. lbs.
1/2 - 20 (.500)	6,600	55 ft. lbs.	41 ft. lbs.
9/16 - 18 (.5625)	8,400	79 ft. lbs.	59 ft. lbs.
5/8 - 18 (.625)	10,575	110 ft. lbs.	83 ft. lbs.
3/4 - 16 (.750)	15,375	192 ft. lbs.	144 ft. lbs.
7/8 - 14 (.875)	12,600	184 ft. lbs.	138 ft. lbs.
1 - 12 (1.000)	16,425	274 ft. lbs.	205 ft. lbs.
1 - 14 (1.000)	16,800	280 ft. lbs.	210 ft. lbs.
1-1/8 - 12 (1.125)	21,150	397 ft. lbs.	297 ft. lbs.
1-1/4 - 12 (1.250)	26,550	553 ft. lbs.	415 ft. lbs.
1-3/8 - 12 (1.375)	32,550	746 ft. lbs.	559 ft. lbs.
1-1/2 - 12 (1.500)	39,150	979 ft. lbs.	734 ft. lbs.



Identification Grade Mark	Specification	Fastener Description	Material	Nominal Size Range (in.)	Mechanical Properties		
					Proof Load (psi)	Yield Strength Min (psi)	Tensile Strength Min (psi)
No Grade Mark	ASTM A307 Grades A&B	Bolts, Screws, Studs	Low Carbon Steel	1/4 thru 4	—	—	60,000
	SAE J429 Grade 2		Low or Medium Carbon Steel	1/4 thru 3/4 Over 3/4 to 1-1/2	55,000 33,000	57,000 36,000	74,000 60,000

* These charts are Industry Guidelines. These specifications may not be suitable for your special application
 * Tightening Torque can vary greatly on different types of Plating.

ENGINEERED COMPONENTS CO.

1100 Davis Road • Elgin, IL 60123
 Phone 847-841-7000 • Fax 847-841-7007
 Web Site: www.engcomponents.com

TIGHTENING TORQUE GUIDE (GUIDELINE ONLY)*

SAE GRADE 5 Coarse Thread

SAE GRADE 5 Fine Thread



RIVETS



Avdel



SIZE	CLAMP LOAD	PLAIN	PLATED
1/4 - 20 (.250)	2,025	8 ft. lbs.	76 in. lbs.
5/16 - 18 (.3125)	3,338	17 ft. lbs.	13 ft. lbs.
3/8 - 16 (.375)	4,950	31 ft. lbs.	23 ft. lbs.
7/16 - 14 (.4375)	6,788	50 ft. lbs.	37 ft. lbs.
1/2 - 13 (.500)	9,075	76 ft. lbs.	57 ft. lbs.
9/16 - 12 (.5625)	11,625	109 ft. lbs.	82 ft. lbs.
5/8 - 11 (.625)	14,400	150 ft. lbs.	112 ft. lbs.
3/4 - 10 (.750)	21,300	266 ft. lbs.	200 ft. lbs.
7/8 - 9 (.875)	29,475	430 ft. lbs.	322 ft. lbs.
1 - 8 (1.000)	38,625	644 ft. lbs.	483 ft. lbs.
1-1/8 - 7 (1.125)	42,375	794 ft. lbs.	596 ft. lbs.
1-1/4 - 7 (1.250)	53,775	1120 ft. lbs.	840 ft. lbs.
1-3/8 - 6 (1.375)	64,125	1470 ft. lbs.	1102 ft. lbs.
1-1/2 - 6 (1.500)	78,000	1950 ft. lbs.	1462 ft. lbs.

SIZE	CLAMP LOAD	PLAIN	PLATED
1/4 - 28 (.250)	2,325	10 ft. lbs.	87 in. lbs.
5/16 - 24 (.3125)	3,675	19 ft. lbs.	14 ft. lbs.
3/8 - 24 (.375)	5,588	35 ft. lbs.	26 ft. lbs.
7/16 - 20 (.4375)	7,575	55 ft. lbs.	41 ft. lbs.
1/2 - 20 (.500)	10,200	85 ft. lbs.	64 ft. lbs.
9/16 - 18 (.5625)	12,975	122 ft. lbs.	91 ft. lbs.
5/8 - 18 (.625)	16,350	170 ft. lbs.	128 ft. lbs.
3/4 - 16 (.750)	23,775	297 ft. lbs.	223 ft. lbs.
7/8 - 14 (.875)	32,475	474 ft. lbs.	355 ft. lbs.
1 - 12 (1.000)	42,300	705 ft. lbs.	529 ft. lbs.
1 - 14 (1.000)	32,275	721 ft. lbs.	541 ft. lbs.
1-1/8 - 12 (1.125)	47,475	890 ft. lbs.	668 ft. lbs.
1-1/4 - 12 (1.250)	59,550	1241 ft. lbs.	930 ft. lbs.
1-3/8 - 12 (1.375)	72,975	1672 ft. lbs.	1254 ft. lbs.
1-1/2 - 12 (1.500)	87,750	2194 ft. lbs.	1645 ft. lbs.



Identification Grade Mark	Specification	Fastener Description	Material	Nominal Size Range (in.)	Mechanical Properties		
					Proof Load (psi)	Yield Strength Min (psi)	Tensile Strength Min (psi)
	SAE J429 Grade 5	Bolts, Screws, Studs	Medium Carbon Steel, Quenched and Tempered	1/4 thru 1	85,000	92,000	120,000
	ASTM A449			Over 1 to 1-1/2	74,000	81,000	105,000
				1/4 thru 1	85,000	92,000	120,000
				Over 1 to 1-1/2	74,000	81,000	105,000
				Over 1-1/2 thru 3	55,000	58,000	90,000



ENGINEERED COMPONENTS CO.

1100 Davis Road • Elgin, IL 60123
 Phone 847-841-7000 • Fax 847-841-7007
 Web Site: www.engcomponents.com

TIGHTENING TORQUE GUIDE (GUIDELINE ONLY)*

SAE GRADE 8 Coarse Thread

SAE GRADE 8 Fine Thread



RIVETS



Avdel



TORX®



SIZE	CLAMP LOAD	PLAIN	PLATED
1/4 - 20 (.250)	2,850	12 ft. lbs.	9 ft. lbs.
5/16 - 18 (.3125)	4,725	25 ft. lbs.	18 ft. lbs.
3/8 - 16 (.375)	6,975	44 ft. lbs.	33 ft. lbs.
7/16 - 14 (.4375)	9,600	70 ft. lbs.	52 ft. lbs.
1/2 - 13 (.500)	12,750	106 ft. lbs.	80 ft. lbs.
9/16 - 12 (.5625)	16,350	153 ft. lbs.	115 ft. lbs.
5/8 - 11 (.625)	20,325	212 ft. lbs.	159 ft. lbs.
3/4 - 10 (.750)	30,075	376 ft. lbs.	282 ft. lbs.
7/8 - 9 (.875)	41,550	606 ft. lbs.	454 ft. lbs.
1 - 8 (1.000)	54,525	909 ft. lbs.	682 ft. lbs.
1-1/8 - 7 (1.125)	68,700	1288 ft. lbs.	966 ft. lbs.
1-1/4 - 7 (1.250)	87,225	1817 ft. lbs.	1363 ft. lbs.
1-3/8 - 6 (1.375)	103,950	2382 ft. lbs.	1787 ft. lbs.
1-1/2 - 6 (1.500)	126,450	3161 ft. lbs.	2371 ft. lbs.

SIZE	CLAMP LOAD	PLAIN	PLATED
1/4 - 28 (.250)	3,263	14 ft. lbs.	10 ft. lbs.
5/16 - 24 (.3125)	5,113	27 ft. lbs.	20 ft. lbs.
3/8 - 24 (.375)	7,875	49 ft. lbs.	37 ft. lbs.
7/16 - 20 (.4375)	10,650	78 ft. lbs.	58 ft. lbs.
1/2 - 20 (.500)	14,400	120 ft. lbs.	90 ft. lbs.
9/16 - 18 (.5625)	18,300	172 ft. lbs.	129 ft. lbs.
5/8 - 18 (.625)	23,025	240 ft. lbs.	180 ft. lbs.
3/4 - 16 (.750)	33,600	420 ft. lbs.	315 ft. lbs.
7/8 - 14 (.875)	45,825	668 ft. lbs.	501 ft. lbs.
1 - 12 (1.000)	59,700	995 ft. lbs.	746 ft. lbs.
1 - 14 (1.000)	61,125	1019 ft. lbs.	764 ft. lbs.
1-1/8 - 12 (1.125)	77,025	1444 ft. lbs.	1083 ft. lbs.
1-1/4 - 12 (1.250)	96,600	2012 ft. lbs.	1509 ft. lbs.
1-3/8 - 12 (1.375)	118,350	2712 ft. lbs.	2034 ft. lbs.
1-1/2 - 12 (1.500)	142,275	3557 ft. lbs.	2668 ft. lbs.



Identification Grade Mark	Specification	Fastener Description	Material	Nominal Size Range (in.)	Mechanical Properties		
					Proof Load (psi)	Yield Strength Min (psi)	Tensile Strength Min (psi)

	SAE J429 Grade 8	Bolts, Screws, Studs	Medium Carbon Alloy Steel, Quenched and Tempered	1/4 thru 1-1/2	120,000	130,000	150,000
	ASTM A354 GradeBD		Alloy Steel, Quenched and Tempered				

* These charts are Industry Guidelines. These specifications may not be suitable for your special application
 * Tightening Torque can vary greatly on different types of Plating.

RECOMMENDED HOLE SIZES FOR THREAD CUTTING SCREWS

THICKNESS	MATERIAL	SCREW SIZE	2-56		4-40		5-40		6-32		8-32	
		DRILL SIZES	NO.	DIA.	NO.	DIA.	NO.	DIA.	NO.	DIA.	NO.	DIA.
UP TO .047	STEEL		50	.070	43	.089	37	.104	35	.110	29	.136
	STAINLESS STEEL*		50	.070	43	.089	37	.104	35	.110	29	.136
	ALUMINUM-SHEET		50	.070	43	.089	37	.101	7/64	.1094	29	.136
.063	STEEL		50	.070	43	.089	37	.104	34	.111	29	.136
	STAINLESS STEEL*		49	.073	42	.093	36	.106	32	.116	28	.140
	ALUMINUM-SHEET		50	.070	43	.089	38	.101	7/64	.1094	29	.136
.094	STEEL		49	.073	42	.093	36	.106	32	.116	28	.140
	STAINLESS STEEL*		49	.073	41	.096	7/64	.1094	32	.116	27	.144
	ALUMINUM-SHEET		50	.070	43	.089	37	.104	33	.113	29	.136
.109	STEEL		49	.073	42	.093	36	.106	32	.116	27	.144
	STAINLESS STEEL*		48	.076	41	.096	7/64	.1094	31	.120	27	.144
	ALUMINUM-SHEET		49	.073	42	.093	37	.104	33	.113	28	.140
.125	STEEL		48	.076	41	.096	7/64	.1094	31	.120	27	.144
	STAINLESS STEEL*		48	.076	40	.098	34	.111	31	.120	26	.147
	ALUMINUM-SHEET		49	.073	42	.093	36	.106	32	.116	28	.140
	CAST ALUMINUM & ZINC DIE CAST		48	.076	40	.098	35	.110	31	.120	26	.147
	CAST IRON		47	.078	38	.101	32	.116	1/8	.125	24	.152
.188	STEEL				38	.101	32	.116	1/8	.125	24	.152
	STAINLESS STEEL*				37	.104	32	.116	30	.128	23	.154
	ALUMINUM-SHEET				40	.098	35	.110	31	.120	26	.147
	CAST ALUMINUM & ZINC DIE CAST				40	.098	34	.111	31	.120	26	.147
	CAST IRON				37	.104	32	.116	30	.128	23	.154
.250	STEEL				37	.104	32	.116	30	.128	23	.154
	STAINLESS STEEL*				37	.104	31	.120	30	.128	5/32	.1562
	ALUMINUM-SHEET				38	.101	33	.113	1/8	.125	25	.149
	CAST ALUMINUM & ZINC DIE CAST				39	.099	33	.113	1/8	.125	25	.149
	CAST IRON				36	.106	31	.120	30	.128	22	.157
.313	STEEL								30	.128	23	.154
	STAINLESS STEEL*								30	.128	5/32	.1562
	ALUMINUM-SHEET								30	.128	23	.154
	CAST ALUMINUM & ZINC DIE CAST								1/8	.125	25	.149
	CAST IRON								30	.128	22	.157

These charts are Industry Guidelines. These specifications may not be suitable for your special application. *Values listed are for #410 corrosion resistant screws in high tensile stainless steel.

RECOMMENDED HOLE SIZES FOR THREAD CUTTING SCREWS

THICKNESS	MATERIAL	SCREW SIZE	10-24		10-32		1/4-20		1/4-28		5/16-18	
		DRILL SIZES	NO.	DIA.	NO.	DIA.	NO.	DIA.	NO.	DIA.	NO.	DIA.
UP TO .047	STEEL		23	.154	20	.161	5	.205	7/32	.2188		
	STAINLESS STEEL*		23	.154	20	.161	4	.209	7/32	.2188		
	ALUMINUM-SHEET		24	.152	20	.161	13/64	.2031	7/32	.2188		
.063	STEEL		23	.154	19	.166	4	.209	7/32	.2188	17/64	.2656
	STAINLESS STEEL*		21	.159	19	.166	3	.213	2	.221	1	.272
	ALUMINUM-SHEET		24	.1562	20	.161	6	.204	7/32	.2188		
.094	STEEL		27	.159	19	.166	3	.213	2	.221	1	.272
	STAINLESS STEEL*		20	.161	18	.169	7/32	.2188	1	.228	J	.277
	ALUMINUM-SHEET		5/32	.1562	19	.166	4	.209	2	.221		
.109	STEEL		20	.161	18	.169	3	.213	1	.228	1	.272
	STAINLESS STEEL*		19	.166	11/64	.1719	7/32	.2188	1	.228	J	.277
	ALUMINUM-SHEET		22	.157	19	.166	4	.209	2	.221		
.125	STEEL		19	.166	18	.169	7/32	.2188	1	.228	J	.277
	STAINLESS STEEL*		19	.166	11/64	.1719	2	.221	1	.228	K	.281
	ALUMINUM-SHEET		21	.159	19	.166	3	.213	2	.221	I	.272
	CAST ALUMINUM & ZINC DIE CAST		19	.166	11/64	.1719	2	.221	1	.228	K	.281
	CAST IRON		17	.173	16	.177	1	.228	15/64	.2344	L	.290
.188	STEEL		17	.173	16	.177	1	.228	15/64	.2344	L	.290
	STAINLESS STEEL*		16	.177	15	.180	A	.234	B	.238	M	.295
	ALUMINUM-SHEET		19	.166	11/64	.1719	2	.221	1	.228	K	.281
	CAST ALUMINUM & ZINC DIE CAST		19	.166	17	.173	2	.221	1	.228	9/32	.2812
	CAST IRON		16	.177	15	.180	15/64	.2344	B	.238	M	.295
.250	STEEL		16	.177	15	.180	A	.234	B	.238	M	.295
	STAINLESS STEEL*		15	.180	14	.182	15/64	.2344	C	.242	19/64	.2969
	ALUMINUM-SHEET		11/64	.1719	16	.177	1	.228	15/64	.2344	L	.290
	CAST ALUMINUM & ZINC DIE CAST		18	.169	17	.173	1	.228	A	.234	9/32	.2812
	CAST IRON		15	.180	14	.182	B	.238	C	.242	19/64	.2969
.313	STEEL		16	.177	15	.180	A	.234	B	.238	M	.295
	STAINLESS STEEL*		15	.180	14	.182	B	.238	C	.242	19/64	.2969
	ALUMINUM-SHEET		16	.177	15	.180	15/64	.2344	B	.238	19/64	.2969
	CAST ALUMINUM & ZINC DIE CAST		11/64	.1719	16	.177	1	.228	A	.234	L	.290
	CAST IRON		15	.180	14	.182	B	.238	C	.242	19/64	.2969
.375 & UP	STEEL		16	.177			A	.234			M	.295
	STAINLESS STEEL*		15	.180			B	.238			19/64	.2969
	ALUMINUM-SHEET		16	.177			15/64	.2344			19/64	.2969
	CAST ALUMINUM & ZINC DIE CAST		11/64	.1719			1	.228			L	.290
	CAST IRON		15	.180			B	.238			19/64	.2969

These charts are Industry Guidelines. These specifications may not be suitable for your special application. *Values listed are for #410 corrosion resistant screws in high tensile stainless steel.

RECOMMENDED HOLE SIZES FOR THREAD CUTTING SCREWS

THICKNESS	MATERIAL	SCREW SIZE	5/16-24		3/8-16		3/8-24					
		DRILL SIZES	NO.	DIA.	NO.	DIA.	NO.	DIA.	NO.	DIA.	NO.	DIA.
UP TO .047	STEEL STAINLESS STEEL* ALUMINUM-SHEET											
.063	STEEL STAINLESS STEEL* ALUMINUM-SHEET		J K	.277 .281	P 21/64	.232 .3281	R 11/32	.339 .3438				
.094	STEEL STAINLESS STEEL* ALUMINUM-SHEET		9/32 9/32	.2812 .2812	21/64 Q	.3281 .332	11/32 S	.3438 .348				
.109	STEEL STAINLESS STEEL* ALUMINUM-SHEET		9/32 L	.2812 .290	Q R	.332 .339	S S	.348 .348				
.125	STEEL STAINLESS STEEL* ALUMINUM-SHEET CAST ALUMINUM & ZINC DIE CAST CAST IRON		L L 9/32 L 19/64	.290 .290 .2812 .290 .2969	R R 21/64 R S	.339 .339 .3281 .339 .348	S S 11/32 S T	.348 .348 .3438 .348 .358				
.188	STEEL STAINLESS STEEL* ALUMINUM-SHEET CAST ALUMINUM & ZINC DIE CAST CAST IRON		M 19/64 L L N	.295 .2969 .290 .290 .302	S S R R T	.348 .348 .339 .339 .358	T 23/64 S S 23/64	.358 .3594 .348 .348 .3594				
.250	STEEL STAINLESS STEEL* ALUMINUM-SHEET CAST ALUMINUM & ZINC DIE CAST CAST IRON		19/64 N M L N	.2969 .302 .295 .290 .302	T T S 11/32 23/64	.358 .358 .348 .3438 .3594	23/64 23/64 T T 23/64	.3594 .3594 .358 .358 .3594				
.313	STEEL STAINLESS STEEL* ALUMINUM-SHEET CAST ALUMINUM & ZINC DIE CAST CAST IRON		19/64 N N N M N	.2969 .302 .302 .295 .302	T T T S 23/64	.358 .358 .358 .348 .3594	23/64 23/64 23/64 T 23/64	.3594 .3594 .3594 .358 .3594				
.375 & UP	STEEL STAINLESS STEEL* ALUMINUM-SHEET CAST ALUMINUM & ZINC DIE CAST CAST IRON		19/64 N N N M N	.2969 .302 .302 .295 .302	T T T S 23/64	.358 .358 .358 .348 .3594	23/64 23/64 23/64 T 23/64	.3594 .3594 .3594 .358 .3595				

These charts are Industry Guidelines. These specifications may not be suitable for your special application. *Values listed are for #410 corrosion resistant screws in high tensile stainless steel.

RECOMMENDED TORQUE-PREVAILING AND FAILURE

Thread Cutting and Thread Forming Screws

Inch Nominal Screw Size	Metric Nominal Screw Size	Thickness Of Plate		Torque											
				Thread Forming			Prevailing Resistance To Loosening ①			Recommended Tightening ②			Failure		
DIA.-T.I.P	DIA.-PITCH	in.	mn.	lb.	in.	Nm	lb.	in.	Nm	lb.	in.	Nm	lb.	in.	Nm
4-49	2.8-0.64	1/32	0.79	2	2.5	0.23-0.28	0.5	1.5	0.06-0.17	6	0.68	8	10*	0.90-1.13	
		1/16	1.59	3	3.5	0.34-0.40	1.5	2	0.17-0.23	9	1.02	15	18*	1.69-2.03	
		3/32	2.38	3	4	0.34-0.45	1.5	2	0.17-0.23	11	1.24	22	27†	2.49-3.05	
		1/8	3.18	3	4	0.34-0.45	1.5	2.5	0.17-0.28	12	1.36	22	27†	2.49-3.05	
5-40	3.2-0.64	1/32	0.79	1	3	0.11-0.34	0.5	1.5	0.06-0.17	6	0.68	10	13**	1.13-1.47	
		1/16	1.59	3.5	5	0.40-0.56	1.5	3	0.17-0.34	12	1.36	22	27**	2.49-3.05	
		3/32	2.38	4	6.5	0.45-0.73	2.5	4	0.28-0.45	18	2.03	34	41*	3.84-4.63	
		1/8	3.18	6	8	0.68-0.90	3.5	5	0.40-0.56	20	2.26	38	46†	4.29-5.20	
6-32	3.5-0.79	1/32	0.79	2	5	0.23-0.56	1	2	0.11-0.23	10	1.13	16	20*	1.81-2.26	
		1/16	1.59	4	7	0.45-0.79	3	4	0.34-0.45	14	1.58	25	30**	2.82-3.39	
		3/32	2.38	6	9	0.68-1.02	3	5	0.34-0.56	20	2.26	35	45†*	3.95-5.08	
		1/8	3.18	6	9	0.68-1.02	4	6	0.45-0.68	22	2.49	39	45†	4.41-5.08	
		5/32	3.97	6	10	0.68-1.13	4	6	0.45-0.68	22	2.49	39	45†	4.41-5.08	
8-32	4.2-0.79	3/16	4.76	7	11	0.79-1.24	4	6	0.45-0.68	22	2.49	39	45†	4.41-5.08	
		1/16	1.59	7	9	0.79-1.02	2	4	0.23-0.45	20	2.26	40	45**	4.52-5.08	
		3/32	2.38	10	13	1.13-1.47	5	7	0.56-0.79	30	3.39	65	75**	7.34-8.47	
		1/8	3.18	11	14	1.24-1.58	4	7	0.45-0.79	45	5.08	75	85†*	8.47-9.60	
		3/16	4.76	16	20	1.81-2.26	8	11	0.90-1.24	45	5.08	75	95†	8.47-10.7	
10-24	4.8-1.06	1/4	6.35	15	18	1.69-2.03	8	11	0.90-1.24	45	5.08	75	95†	8.47-10.7	
		1/16	1.59	10	14	1.13-1.58	4	7	0.45-0.79	25	2.82	35	45*	3.95-5.08	
		3/32	2.38	14	18	1.58-2.03	5	8	0.56-0.90	35	3.95	65	80*	7.34-9.04	
		1/8	3.18	14	18	1.58-2.03	5	8	0.56-0.90	45	5.08	80	95*	9.04-10.7	
		3/16	4.76	17	22	1.92-2.49	9	13	1.02-1.47	55	6.21	100	115†	11.3-13.0	
10-32	4.8-0.79	1/4	6.35	13	17	1.47-1.92	4	8	0.45-0.90	55	6.21	100	115†	11.3-13.0	
		1/16	1.59	7	11	0.79-1.24	5	8	0.56-0.90	25	2.82	55	65*	6.21-7.34	
		3/32	2.38	11	14	1.24-1.58	9	13	1.02-1.47	35	3.95	80	95*	9.04-10.7	
		1/8	3.18	12	16	1.36-1.81	9	13	1.02-1.47	50	5.65	95	110*	10.7-12.4	
		3/16	4.76	19	25	2.15-2.82	12	16	1.36-1.81	70	7.91	115	140†	13.0-15.8	
12-24	5.5-1.06	1/4	6.35	18	23	2.03-2.60	11	17	1.24-1.92	70	7.91	115	140†	13.0-15.8	
		3/32	2.38	16	21	1.81-2.37	5	8	0.56-0.90	40	4.52	75	95*	8.47-10.7	
		1/8	3.18	19	24	2.15-2.71	9	12	1.02-1.36	65	7.34	95	115*	10.7-13.0	
		3/16	4.76	21	26	2.37-2.94	10	14	1.13-1.58	75	8.47	135	155*	15.3-17.5	
		1/4	6.35	21	26	2.37-2.94	9	13	1.02-1.47	85	9.60	150	170†	16.9-19.2	
		5/16	7.94	24	27	2.71-3.05	10	14	1.13-1.58	85	9.60	150	170†	16.9-19.2	
1/4-20	6.3-1.27	3/32	2.38	28	35	3.16-3.95	12	17	1.36-1.92	70	7.91	135	150*	15.3-16.9	
		1/8	3.18	30	36	3.39-4.07	18	25	2.03-2.82	85	9.60	170	195*	19.2-22.0	
		3/16	4.76	45	55	5.08-6.21	25	35	2.82-3.95	125	14.1	205	235†	23.2-26.6	
		1/4	6.35	55	65	6.21-7.34	25	35	2.85-3.95	125	14.1	205	235†	23.2-26.6	
5/16-18	7.9-1.41	5/16	7.94	55	65	6.21-7.34	25	35	2.82-3.95	125	14.1	205	235†	23.2-26.6	
		1/8	3.18	55	65	6.21-7.34	30	40	3.39-4.52	120	13.6	270	300*	30.5-33.9	
		3/16	4.76	75	85	8.47-9.60	40	50	4.52-5.65	160	18.1	380	410*	42.9-46.3	
		1/4	6.35	75	85	8.47-9.60	40	50	4.52-5.65	225	25.4	425	465†*	48.0-53	
		5/16	7.94	80	90	9.04-10.2	55	65	6.21-7.34	250	28.2	450	500†	51-56	
3/8-16	9.5-1.59	3/8	9.53	100	110	11.3-12.4	55	65	6.21-7.34	250	28.2	450	500†	51-56	
		1/4	6.35	90	100	10.2-11.3	45	55	5.08-6.21	350	39.5	825	875*	93-99	
		5/16	7.94	110	125	12.4-14.1	50	60	5.65-6.78	400	45.2	950	1000*	107-113	
		3/8	9.53	95	110	10.7-12.4	30	45	3.39-5.08	450	51	950	1000*	107-113	
		1/2	12.70	120	140	13.6-15.8	45	60	5.08-6.78	500	56	1050	1100†	119-124	

* Probability internal threads will strip.

1. Prevailing resistance to loosening torque is an indication of the resistance of TAPTITE screws to loosening under vibration without the heads being seated
 2. Recommended tightening torque induces approximately 30,000 to 50,000 psi (210 to 345 MPa) clamping stress.

† Probability screw will break
 ① and ② See NOTES

Values shown are for conditions stated only! Thicker or thinner, harder or softer materials, different hole sizes with resultant higher or lower thread percentages and finishes other than cadmium plate, all contribute to variations in torque performance. Consult our Engineering Department for specific application data. Above figures are guidelines only.

HOLE SIZES* FOR WOOD SCREWS

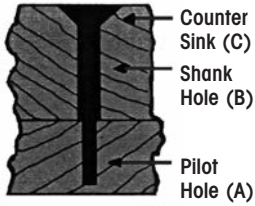

Pilot Holes

Pilot holes for wood screws are recommended, especially for hard woods. They greatly lessen the possibility of damage to screws and to the wood. The hole in the first piece of wood should be bored large enough to accommodate freely the screw shank.

In the the second piece of wood the hole should be slightly smaller than the screw shank, as shown in the chart below. The hole depth should be about one-half the length of the screw in the second piece of wood. the length of the screw chosen for the job will properly be at least an 1/8" shorter than the combined thickness of the wood.

Screw Size	Pilot Hole (A)				Shank Clearance Hole (B)		Counter Sink (C)
	Hard Woods		Soft Woods		Twist Bit (Nearest size in fractions of an inch)	Drill Gauge No. To be used for maximum holding power	Number of Auger Bits To counterbore for sinking head (by 16ths)
	Twisted Bit (Nearest size in fractions of an inch)	Drill Gauge No. To be used for maximum holding power	Twist Bit (Nearest size in fractions of an inch)	Drill Gauge No. To be used for maximum holding power			
2	–	54	1/32	65	3/32	42	3
3	1/16	53	3/64	58	7/64	37	4
4	1/16	51	3/64	55	7/64	32	4
5	5/64	47	1/16	53	1/8	30	4
6	–	44	1/16	52	9/64	27	5
7	–	39	1/16	51	5/32	22	5
8	7/64	35	5/64	48	11/64	18	6
9	7/64	33	5/64	45	3/16	14	6
10	1/8	31	3/32	43	3/16	10	6
11	–	29	3/32	40	13/64	4	7
12	–	25	7/64	38	7/32	2	7
14	3/16	14	7/64	32	1/4	D	8
16	–	10	9/64	29	17/64	I	9
18	13/64	6	9/64	26	19/64	N	10
20	7/32	3	11/64	19	21/64	P	11
24	1/4	D	3/16	15	3/8	V	12

* Sizes for holes recommended for average application. Slightly larger holes may be required.

visit our web site for a video tour
www.engcomponents.com



HOLE SIZES¹ FOR THREAD FORMING SCREWS

TYPE A, AB AND B THREAD FORMING SCREWS IN SHEET METALS

Screw Size	Total Metal Thickness (decimal)	Type A ² For Steel, Stainless Steel, Monel, Brass & Aluminum Alloy			Type AB and B For Steel, Stainless Steel, Monel & Brass			Type AB and B For Aluminum Alloys		
		Pierced or Extruded Hole	Drilled or Clean Punched Hole		Pierced or Extruded Hole	Drilled or Clean Punched Hole		Pierced or Extruded Hole	Drilled or Clean Punched Hole	
			Hole Diameter	Hole Diameter ³		Drill Size No.	Hole Diameter		Hole Diameter ³	Drill Size No.
4	0.015	–	0.086	44	0.086	0.086	44	–	–	–
	0.018	–	0.086	44	0.086	0.086	44	–	–	–
	0.024	0.098	0.094	42	0.098	0.089	43	0.086	–	–
	0.030	0.098	0.094	42	0.098	0.094	42	0.086	0.086	44
	0.036	0.098	0.098	40	0.098	0.094	42	0.086	0.086	44
	0.048				–	0.096	41	0.086	0.086	44
	0.060				–	0.100	39	–	0.089	43
	0.075				–	0.102	38	–	0.089	43
	0.105				–				0.094	42
6	0.015	–	0.104	37	0.111	0.104	37	–	–	–
	0.018	–	0.104	37	0.111	0.104	37	–	–	–
	0.024	0.111	0.104	37	0.111	0.106	36	0.111	–	–
	0.030	0.111	0.104	37	0.111	0.106	36	0.111	0.104	37
	0.036	0.111	0.106	36	0.111	0.110	35	0.111	0.104	37
	0.048				–	0.111	34	0.111	0.104	37
	0.060				–	0.116	32	–	0.106	36
	0.075				–	0.120	31	–	0.110	35
	0.105				–	0.128	30	–	0.111	34
	0.128 to 0.250	–	–	–	–	–	–	–	0.120	31
7	0.015	–	0.116	32						
	0.018	–	0.116	32	0.120	0.116	32	–	–	–
	0.024	0.120	0.116	32	0.120	0.116	32	0.120	–	–
	0.030	0.120	0.116	32	0.120	0.116	32	0.120	0.113	33
	0.036	0.120	0.116	32	0.120	0.116	32	0.120	0.113	33
	0.048	0.120	0.120	31	0.120	0.120	31	0.120	0.116	32
	0.060				–	0.128	30	–	0.120	31
	0.075				–	0.136	29	–	0.128	30
	0.105				–	0.140	28	–	0.136	29
	0.128 to 0.250	–	–	–	–	–	–	–	0.136	29
8	0.018	–	0.125	1/8	0.136	–	–	–	–	–
	0.024	0.136	0.125	1/8	0.136	0.125	1/8	0.136	–	–
	0.030	0.136	0.125	1/8	0.136	0.125	1/8	0.136	0.116	32
	0.036	0.136	0.125	1/8	0.136	0.125	1/8	0.136	0.120	31
	0.048	0.136	0.128	30	0.136	0.128	30	0.136	0.128	30
	0.060				–	0.136	29	–	0.136	29
	0.075				–	0.140	28	–	0.140	28
	0.105				–	0.150	25	–	0.147	26
	0.125				–	0.150	25	–	0.147	26
	0.162 to 0.375	–	–	–	–	–	–	–	0.152	24

1. Because conditions differ widely, it may be necessary to vary the hole size slightly to suit a particular application. 2. Type AB screws, because they offer wider versatility of application, are recommended over Type A screws. 3. Decimals shown are standard drill sizes, rounded to nearest 0.001 inch. 4. Hole sizes shown in **bold** face type apply to Type B only.

HOLE SIZES¹ FOR THREAD FORMING SCREWS

TYPE A, AB AND B THREAD FORMING SCREWS IN SHEET METALS

Screw Size	Total Metal Thickness (decimal)	Type A ² For Steel, Stainless Steel, Monel, Brass & Aluminum Alloy			Type AB and B For Steel, Stainless Steel, Monel & Brass			Type AB and B For Aluminum Alloys		
		Pierced or Extruded Hole	Drilled or Clean Punched Hole		Pierced or Extruded Hole	Drilled or Clean Punched Hole		Pierced or Extruded Hole	Drilled or Clean Punched Hole	
			Hole Diameter	Hole Diameter ³		Drill Size No.	Hole Diameter		Hole Diameter ³	Drill Size No.
10	0.018	–	0.136	29	0.157	–	–	–	–	–
	0.024	0.157	0.136	29	0.157	0.144	27	0.157	–	–
	0.030	0.157	0.136	29	0.157	0.144	27	0.157	–	–
	0.036	0.157	0.136	29	0.157	0.147	26	0.157	0.144	27
	0.048	0.157	0.149	25	0.157	0.152	24	0.157	0.144	27
	0.060				–	0.152	24	–	0.144	27
	0.075				–	0.157	22	–	0.147	26
	0.105				–	0.161	20	–	0.147	26
	0.125				–	0.170	18	–	0.154	23
	0.135				–	0.170	18	–	0.154	23
	0.164				–	0.173	17	–	0.159	21
0.200 to 0.375	–	–	–	–	–	–	–	0.166	19	
12	0.024	–	0.161	20	0.185	0.166	19	–	–	–
	0.030	0.185	0.161	20	0.185	0.166	19	–	–	–
	0.036	0.185	0.161	20	0.185	0.166	19	–	–	–
	0.048	0.185	0.161	20	0.185	0.170	18	–	0.161	20
	0.060				–	0.177	16	–	0.166	19
	0.075				–	0.182	14	–	0.173	17
	0.105				–	0.185	13	–	0.180	15
	0.125				–	0.196	9	–	0.182	14
	0.135				–	0.196	9	–	0.182	14
	0.164				–	0.201	7	–	0.189	12
	0.200 to 0.375				–	–	–	–	0.196	9
14 1/4	0.024	–	0.185	13	–	–	–	–	–	–
	0.030	0.209	0.189	12	0.209	0.194	10	–	–	–
	0.036	0.209	0.191	11	0.209	0.194	10	–	–	–
	0.048	0.209	0.196	9	0.209	0.194	10	–	–	–
	0.060				–	0.199	8	–	0.199	8
	0.075				–	0.204	6	–	0.201	7
	0.105				–	0.209	4	–	0.204	6
	0.125				–	0.228	1	–	0.209	4
	0.135				–	0.228	1	–	0.209	4
	0.164				–	0.234	15/64	–	0.213	3
	0.187				–	0.234	15/64	–	0.213	3
0.194				–	0.234	15/64	–	0.221	2	
0.200 to 0.375	–	–	–	–	–	–	–	0.228	1	

1. Because conditions differ widely, it may be necessary to vary the hole size slightly to suit a particular application. 2. Type AB screws, because they offer wider versatility of application, are recommended over type A screws. 3. Decimals shown are standard drill sizes, rounded to nearest 0.001 inch. 4. Hole sizes shown in bold face type apply to Type B only.

visit our web site for a video tour
www.engcomponents.com

FACTORY STANDARDS LABORATORY INC.

Minimum Tensile Strength or Breakload in lbs.

		Grade 1	Grade 2	Grade 4	Grade 5 and 5.2 ^b	Grade 5.1	Grade 7	Grade 8 8.1, 8.2 ^b
Normal Dia. of Product and Threads per in.	Stress area, in ²	Tensile strength Min, lb	Tensile strength Min, lb	Tensile strength Min, lb	Tensile strength Min, lb	Tensile strength Min, lb	Tensile strength Min, lb	Tensile strength Min, lb
COURSE THREAD SERIES UNC								
No.								
6-32	.00909					1100		
8-32	.0140					1700		
10-24	.0175					2100		
12-24	.0242					2900		
1/4-20	.0318	1900	2350	3650	3800	3800	4250	4750
5/16-18	.0524	3150	3900	6000	6300	6300	6950	7850
3/8-16	.0775	4650	5750	8400	9300	9300	10300	11600
7/16-14	.1063	6400	7850	12200	12800	12800	14100	15900
1/2-13	.1419	8500	10500	16300	17000	17000	18900	21300
9/16-12	.182	10900	13500	20900	21800	21800	24200	27300
5/8-11	.226	13600	16700	25400	27100	27100	30100	33900
3/4-10	.334	20000	24700	38400	40100		44400	50100
7/8-9	.462	27700	27700	53100	55400		61400	69300
1-8	.606	36400	36400	69700	72700		80600	90900
FINE THREAD SERIES UNC								
No.								
6-40	.01015					1200		
8-36	.01474					1750		
10-32	.0200					2400		
12-28	.0258					3100		
1/4-28	.0364	2200	2700	4200	4350	4350	4850	5450
5/16-24	.0580	3500	4300	6700	6950	6950	7700	8700
3/8-24	.0878	5250	6500	10100	10500	10500	11700	13200
7/16-20	.1187	7100	8800	13650	14200	14200	15800	17800
1/2-20	.1599	9600	11800	18400	19200	19200	21300	24000
9/16-18	.203	12200	15000	23300	24400	24400	27000	30400
5/8-18	.256	15400	18900	29400	30700	30700	34000	38400
3/4-16	.373	22400	27600	42900	44800		49600	56000
7/8-14	.509	30500	30500	58500	61100		67700	76400
1-12	.663	39800	39800	76200	79600		88200	99400

(b) Grades 5.2 and 8.2 applicable to sizes 1/4 through 1 inch.

Value from SAE J429h

TORQUE GUIDE

TORQUE CHART "STAINLESS STEEL NUTS"

BOLT SIZE	TYPE 304 STAINLESS STEEL	TYPE 316 STAINLESS STEEL
2-56	2.5	2.6
2-64	3	3.2
3-48	3.9	4
3-56	4.4	4.6
4-40	5.2	5.5
4-48	6.6	6.9
5-40	7.7	8.1
5-44	9.4	9.8
6-32	9.6	10.1
6-40	12.1	12.7
8-32	19.8	20.7
8-36	22	23
10-24	22.8	23.8
10-32	31.7	33.1
1/4-20	75.2	78.8
1/4-28	94	99
5/16-18	132	138
5/16-24	142	147
3/8-16	236	247
3/8-24	259	271
7/16-14	376	393
7/16-20	400	418
1/2-13	517	542
1/2-20	541	565
9/16-12	682	713
9-16-18	752	787
5/8-11	1110	1160
5/8-18	1244	1301
3/4-10	1530	1582
3/4-16	1490	1558
7/8-9	2328	2430
7/8-14	2318	2420
1-8	3440	3595
1-14	3110	3250
1-1/8-7	413	432
1-1/8-12	390	408
1-1/4-7	523	546
1-1/4-12	480	504
1-1/2-6	888	930
1-1/2-12	703	732

Source: ITT Harper

Suggest Max Torquing Values- a guide based upon industry tests on dry products wiped clean.

Values thru 1" diameter are stated in inch pounds, over 1" diameter in foot pounds.

The 3/8" diameter and under metal products were roll-threaded and, where size range permitted were made on bolt maker equipment.

inch pounds to foot pounds multiply by 12

foot pounds to inch pounds divide by 12

may not be suitable for your application

POINT OF SCREW	SCREW SIZE DIA.	Material Thickness Guidelines For Self-Drilling Screws										DRILL SPEED RPM*
		.050	.100	.150	.200	.250	.300	.350	.400	.500	.600	
	6	.035 — 0.90										2500
#2	8	.035 — .104										2500
	10	.035 — .110										2250
	1/4	.035 — .176										2250
	10	.035 — .176										2250
#3	12	.110 — .210										2000
	1/4	.110 — .240										1750
#4	12	.187 — .312										1500
#5	12	.187 — .500										1500

Type BSD Self-Drilling Screw Selection Chart			
Nominal Screw Size	Point Style	Recommended Panel Thickness, in	
		Min.	Max.
6	2	.035	.090
8	2	.035	.100
10	2	.035	.110
10	3	.110	.175
12	3	.110	.210
1/4	3	.110	.220

*Performance may vary in certain applications. Drill speeds are only recommendations. The above graph is intended as a guide and does not constitute a warranty of any type.

Pullout Values For Self-Drilling Screws: One Piece Metal

			POUNDS								
SIZE	POINT	GAUGE	22	20	18	16	14	12	1/8	3/16	1/4
6-20	2		149	277	462	571	855	1043			
8-18	2		260	292	479	685	933	1533			
10-16	2		267	360	534	763	1005	1606			
10-16	3		261	293	487	690	941	1432	2017		
12-14	3		283	333	537	737	1034	1585	2349	2911	
12-24	4				484	679	959	1489	2371	3384	3732
12-24	5				475	672	951	1486	2269	3593	3882
14-14	3		287	339	595	856	1114	1805	2337	4416	4885

Shear Strength Value For Self-Drilling Screws: Metal to Metal

			POUNDS								
SIZE	POINT	GAUGE	22-22	20-20	18-18	16-16	14-14	12-12	1/8-1/8	3/16-3/16	1/4-1/4
6-20	2										
8-18	2		546	721	1031	1049					
10-16	2		574	808	1173	1233					
10-16	3			709	1231	1497	1508				
12-14	3			749	1320	1574	1914	1929			
12-24	4							1989	1972		
12-24	5								2622	2641	2682
14-14	3			905	1401	2040	2509	2573	2738		

DRILL SIZES

Decimal Equivalents (Inches)

Number Drills					
Same as Stub's Steel Wire Gage					
Size	Drill Dia.	Size	Drill Dia.	Size	Drill Dia.
1	0.2280	28	0.1405	55	0.0520
2	0.2210	29	0.1360	56	0.0465
3	0.2130	30	0.1285	57	0.0430
4	0.2090	31	0.1200	58	0.0420
5	0.2055	32	0.1160	59	0.0410
6	0.2040	33	0.1130	60	0.0400
7	0.2010	34	0.1110	61	0.0390
8	0.1990	35	0.1100	62	0.0380
9	0.1960	36	0.1065	63	0.0370
10	0.1935	37	0.1040	64	0.0360
11	0.1910	38	0.1015	65	0.0350
12	0.1890	39	0.0995	66	0.0330
13	0.1850	40	0.0980	67	0.0320
14	0.1820	41	0.0960	68	0.0310
15	0.1800	42	0.0935	69	0.0292
16	0.1770	43	0.0890	70	0.0280
17	0.1730	44	0.0860	71	0.0260
18	0.1695	45	0.0820	72	0.0250
19	0.1660	46	0.0810	73	0.0240
20	0.1610	47	0.0785	74	0.0225
21	0.1590	48	0.0760	75	0.0210
22	0.1570	49	0.0730	76	0.0200
23	0.1540	50	0.0700	77	0.0180
24	0.1520	51	0.0670	78	0.0160
25	0.1495	52	0.0635	79	0.0145
26	0.1470	53	0.0595	80	0.0135
27	0.1440	54	0.0550		

Letter Drills					
Size	Drill Dia.	Size	Drill Dia.	Size	Drill Dia.
A	0.234	J	0.277	S	0.348
B	0.238	K	0.281	T	0.358
C	0.242	L	0.290	U	0.368
D	0.246	M	0.295	V	0.377
E	0.250	N	0.302	W	0.386
F	0.257	O	0.316	X	0.397
G	0.261	P	0.323	Y	0.404
H	0.266	Q	0.332	Z	0.413
I	0.272	R	0.339		

WIRE & SHEET GAGES - Steel

Decimal Equivalents (Inches)

Number of Gage	Amer Steel & Wire Washburn & Moen WIRE	Unites States Standard Gage SHEET
7 / 0	0.4900	0.5000
6 / 0	0.4615	0.4688
5 / 0	0.4305	0.4375
4 / 0	0.3938	0.4063
3 / 0	0.3625	0.3750
2 / 0	0.3310	0.3438
0	0.3065	0.3125
1	0.2830	0.2813
2	0.2625	0.2656
3	0.2437	0.2500
4	0.2253	0.2344
5	0.2070	0.2188
6	0.1920	0.2031
7	0.1770	0.1875
8	0.1620	0.1719
9	0.1483	0.1563
10	0.1350	0.1406
11	0.1205	0.1250
12	0.1055	0.1094
13	--	0.0938
14	0.0800	0.0781
15	0.0720	0.0703
16	0.0625	0.0625
17	0.0540	0.0563
18	0.0475	0.0500
19	0.0410	0.0438
20	0.0348	0.0375
21	0.0318	0.0344
22	0.0286	0.0313
23	0.0258	0.0281
24	0.0230	0.0250
25	0.0204	0.0219
26	0.0181	0.0188
27	0.0173	0.0172
28	0.0162	0.0156
29	0.0150	0.0141
30	0.0140	0.0125
31	0.0132	0.0109
32	0.0128	0.0102
33	0.0118	0.0094
34	0.0104	0.0086
35	0.0095	0.0078
36	0.0090	0.0070
37	0.0085	0.0066
38	0.0080	0.0063

UNIFIED EXTERNAL SCREW THREADS

American Standard ASA B1.1 - 1960
 Classes 2A & 3A-UNRC, UNRF, UNC, UNF

Nominal Size & TPI	Class 2A		Class 3A	
	Pitch	Major	Pitch	Major
	Diameter	Diameter	Diameter	Diameter
1/4 - 20	0.2127	0.2408	0.2147	0.2419
	0.2164	0.2489	0.2175	0.2500
1/4 - 28	0.2225	0.2425	0.2243	0.2435
	0.2258	0.2490	0.2268	0.2500
5/16 - 18	0.2712	0.3026	0.2734	0.3038
	0.2752	0.3113	0.2764	0.3125
5/16 - 24	0.2806	0.3042	0.2827	0.3053
	0.2843	0.3114	0.2854	0.3125
3/8 - 16	0.3287	0.3643	0.3311	0.3656
	0.3331	0.3737	0.3344	0.3750
3/8 - 24	0.3430	0.3667	0.3450	0.3678
	0.3468	0.3739	0.3479	0.3750
7/16 - 14	0.3850	0.4258	0.3876	0.4272
	0.3897	0.4361	0.3911	0.4375
7/16 - 20	0.3995	0.4281	0.4019	0.4294
	0.4037	0.4362	0.4050	0.4375
1/2 - 13	0.4435	0.4876	0.4463	0.4891
	0.4485	0.4985	0.4500	0.5000
1/2 - 20	0.4619	0.4906	0.4643	0.4919
	0.4662	0.4987	0.4675	0.5000
9/16 - 12	0.5016	0.5495	0.5045	0.5511
	0.5068	0.5609	0.5084	0.5625
9/16 - 18	0.5205	0.5524	0.5230	0.5538
	0.5250	0.5611	0.5264	0.5625
5/8 - 11	0.5589	0.6113	0.5619	0.6129
	0.5644	0.6234	0.5660	0.6250
5/8 - 18	0.5828	0.6149	0.5854	0.6163
	0.5875	0.6236	0.5889	0.6250
3/4 - 10	0.6773	0.7353	0.6806	0.7371
	0.6832	0.7482	0.6850	0.7500

Engineered Components

847-841-7000 • Fax 847-841-7007



Aerial of Elgin Facility



Elgin Entrance



Sales Team



Decal Department



Product Library

Engineered Components

visit our web site for a video tour
www.engcomponents.com



Elgin Warehouse

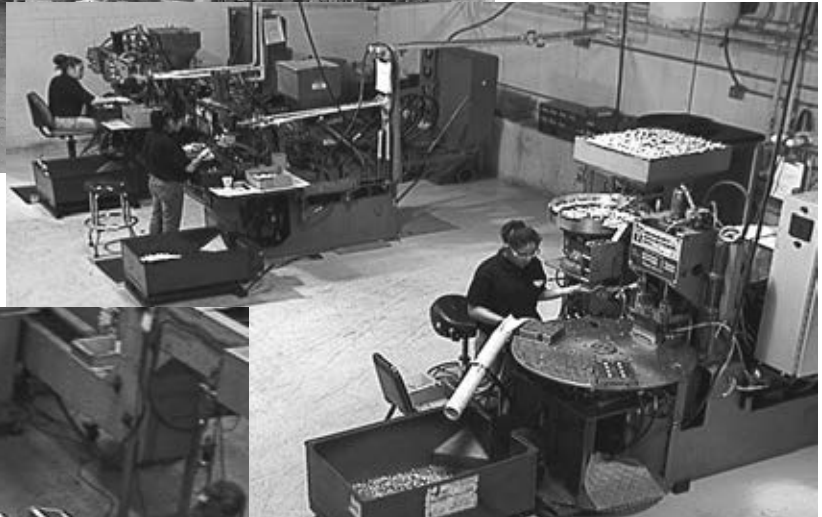

Bagging and Boxing Room



Molding Room

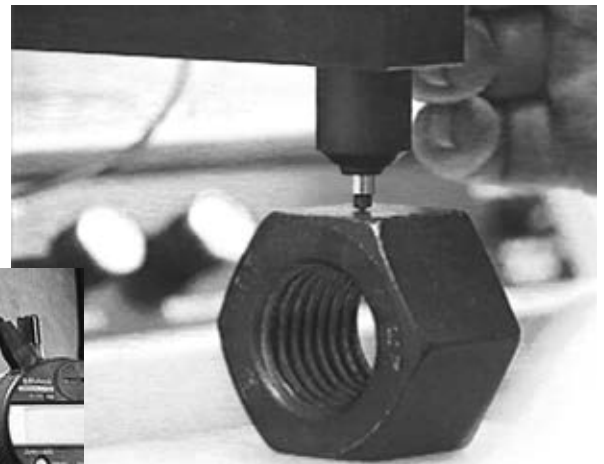

Quality Control

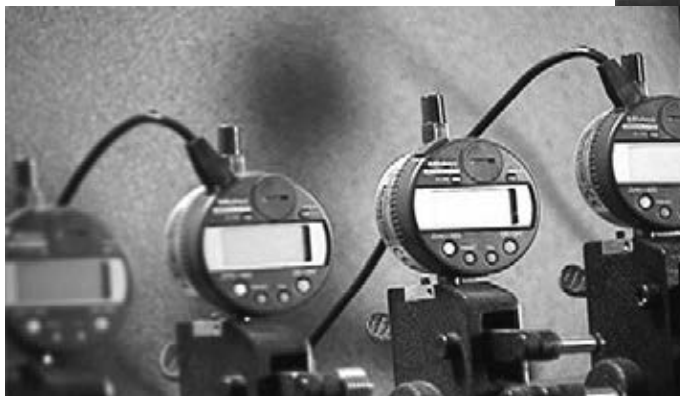

Engineered Components

847-841-7000 • Fax 847-841-7007



Lafayette Exterior

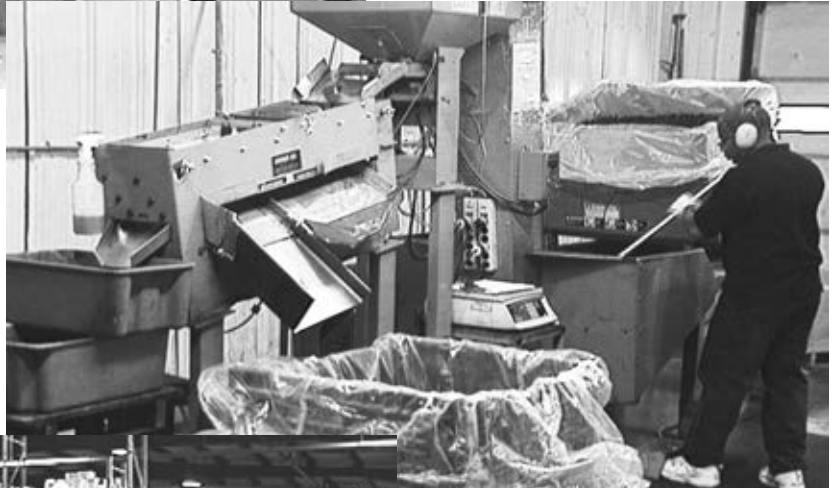

Roll Sort Machine



Lafayette Warehouse

Engineered Components

visit our web site for a video tour
www.engcomponents.com

1100 Davis Road
 Elgin, Illinois 60123
 Phone: 847.841.7000
 Fax: 847.841.7007
 web site: www.engcomponents.com

DECIMALS		MILLIMETERS	DECIMALS		MILLIMETERS	MM	INCHES	MM	INCHES
	$\frac{1}{64}$	0.015625	0.397	$\frac{33}{64}$	0.515625	13.097	.1	.0039	46—1.8110
$\frac{1}{32}$	$\frac{3}{64}$.03125	0.794	$\frac{17}{32}$.53125	13.494	.2	.0079	47—1.8504
	$\frac{5}{64}$.078125	1.191	$\frac{35}{64}$.546875	13.891	.3	.0118	48—1.8898
$\frac{1}{16}$	$\frac{7}{64}$.109375	1.588	$\frac{9}{16}$.5625	14.288	.4	.0157	49—1.9291
	$\frac{9}{64}$.140625	1.984	$\frac{37}{64}$.578125	14.684	.5	.0197	50—1.9685
$\frac{3}{32}$	$\frac{11}{64}$.171875	2.381	$\frac{19}{32}$.59375	15.081	.6	.0236	51—2.0079
	$\frac{13}{64}$.203125	2.778	$\frac{39}{64}$.609375	15.478	.7	.0276	52—2.0472
$\frac{1}{8}$	$\frac{15}{64}$.234375	3.175	$\frac{41}{64}$.6250	15.875	.8	.0315	53—2.0866
	$\frac{17}{64}$.265625	3.572	$\frac{21}{32}$.640625	16.272	.9	.0354	54—2.1260
$\frac{5}{32}$	$\frac{19}{64}$.296875	3.969	$\frac{43}{64}$.65625	16.669	1	.0394	55—2.1654
	$\frac{21}{64}$.328125	4.366	$\frac{45}{64}$.671875	17.066	2	.0787	56—2.2047
$\frac{3}{16}$	$\frac{23}{64}$.359375	4.763	$\frac{47}{64}$.6875	17.463	3	.1181	57—2.2441
	$\frac{25}{64}$.390625	5.159	$\frac{49}{64}$.703125	17.859	4	.1575	58—2.2835
$\frac{7}{32}$	$\frac{27}{64}$.421875	5.556	$\frac{51}{64}$.71875	18.256	5	.1969	59—2.3228
	$\frac{29}{64}$.453125	5.953	$\frac{53}{64}$.734375	18.653	6	.2362	60—2.3622
$\frac{1}{4}$	$\frac{31}{64}$.484375	6.350	$\frac{55}{64}$.7500	19.050	7	.2756	61—2.4016
	$\frac{33}{64}$.515625	6.747	$\frac{57}{64}$.765625	19.447	8	.3150	62—2.4409
$\frac{9}{32}$			7.144	$\frac{59}{64}$.78125	19.844	9	.3543	63—2.4803
			7.541	$\frac{61}{64}$.796875	20.241	10	.3937	64—2.5197
$\frac{5}{16}$			7.938	$\frac{63}{64}$.8125	20.638	11	.4331	65—2.5591
			8.334		.828125	21.034	12	.4724	66—2.5984
$\frac{3}{8}$			8.731	$\frac{23}{32}$.84375	21.431	13	.5118	67—2.6378
			9.128	$\frac{47}{64}$.859375	21.828	14	.5512	68—2.6772
$\frac{7}{8}$			9.525	$\frac{49}{64}$.8750	22.225	15	.5906	69—2.7165
			9.922	$\frac{51}{64}$.890625	22.622	16	.6299	70—2.7559
$\frac{13}{32}$			10.319	$\frac{53}{64}$.90625	23.019	17	.6693	71—2.7953
			10.716	$\frac{55}{64}$.921875	23.416	18	.7087	72—2.8346
$\frac{7}{16}$			11.113	$\frac{57}{64}$.9375	23.813	19	.7480	73—2.8740
			11.509	$\frac{59}{64}$.953125	24.209	20	.7874	74—2.9134
$\frac{15}{32}$			11.906	$\frac{61}{64}$.96875	24.606	21	.8268	75—2.9528
			12.303	$\frac{63}{64}$.984375	25.003	22	.8661	76—2.9921
$\frac{1}{2}$			12.700		1.000	25.400	23	.9055	77—3.0315
							24	.9449	78—3.0709
							25	.9843	79—3.1102
							26	1.0236	80—3.1496
							27	1.0630	81—3.1890
							28	1.1024	82—3.2283
							29	1.1417	83—3.2677
							30	1.1811	84—3.3071
							31	1.2205	85—3.3465
							32	1.2598	86—3.3858
							33	1.2992	87—3.4252
							34	1.3386	88—3.4646
							35	1.3780	89—3.5039
							36	1.4173	90—3.5433
							37	1.4567	91—3.5827
							38	1.4961	92—3.6220
							39	1.5354	93—3.6614
							40	1.5748	94—3.7008
							41	1.6142	95—3.7402
							42	1.6535	96—3.7795
							43	1.6929	97—3.8189
							44	1.7323	98—3.8583
							45	1.7717	99—3.8976
									100—3.9370

1 mm = .03937"

.001" = .0254 mm

Poly Seal® is a trademark of Engineered Components Company
 Torx® is a trademark of Camcar Div. of Textron
 Corroflo is a trademark of Camcar Div. of Textron
 Camtainer is a trademark of Camcar Div. of Textron

Engineered Components

COMPANY

1100 Davis Road
Elgin, Illinois 60123
Phone: 847.841.7000
Fax: 847.841.7007
web site: www.engcomponents.com

POP[®] FASTENERS
A  **BLACK & DECKER COMPANY**

Southco
DRIVE RIVETS

Avdel Cherry
TEXTRON

CAMCAR TEXTRON
Camcar Division of Textron Inc.

 **OLYMPIC FASTENING SYSTEMS, INC.**

TRW

Tinnerman[®] Brand Fasteners

CORROFLO[®]

EAT•N Retaining Rings
Snap Rings

T-MARKED
Speed Nuts[®]

 **HUCK**
A  **TIMBOLD COMPANY**

Huck International, Inc.
Advanced Fastening Systems

HEYCO[®]

CAMTAINER[®]

ITW Fastex[®]

ARK-LES
CORPORATION

GESIPA[®]

Palnut[®]

DYNACAST

TORX[®]

 **INFASCO**

Fastex[®] is a registered trademark of ITW
Poly Seal[®] is a trademark of Engineered Components Company
Torx[®] is a trademark of Camcar Div. of Textron
Corroflo is a trademark of Camcar Div. of Textron
Camtainer is a trademark of Camcar Div. of Textron